

...Dialight



# Obstruction LED Solutions

High, Medium & Low Intensity Systems



FEB 2020

# DIALIGHT IS THE INNOVATION AND MARKET LEADER IN LED OBSTRUCTION SOLUTIONS FOR MORE THAN 20 YEARS

## SAFE

Dialight LED systems have Infrared (IR) LEDs for visibility by pilots utilizing Night Vision Goggles (NVGs) or Night Vision Imaging Systems (NVIS).



## DIFFERENTIATED

Dialight offers the industry's most comprehensive, energy-efficient and reliable line of LED-based obstruction solution systems in the world. Our precision patented optics ensure maximum safety with minimal ground scatter for community-friendly illumination.



## CONVENIENT

Dialight systems offer a small, light-weight flash head for ease of installation, while our low-maintenance fixtures virtually eliminate tower climbs and unplanned site visits for years, dramatically reducing maintenance costs and non-compliance risk.



## INTELLIGENT

Dialight controlled LED Obstruction solutions can be seamlessly integrated into existing operation and control centers while providing additional valuable information, both locally and remotely.



## TRUSTED

Every Dialight LED Obstruction system is fully certified and compliant with FAA, TC, ICAO, and international standards, for dependability and performance you can trust.

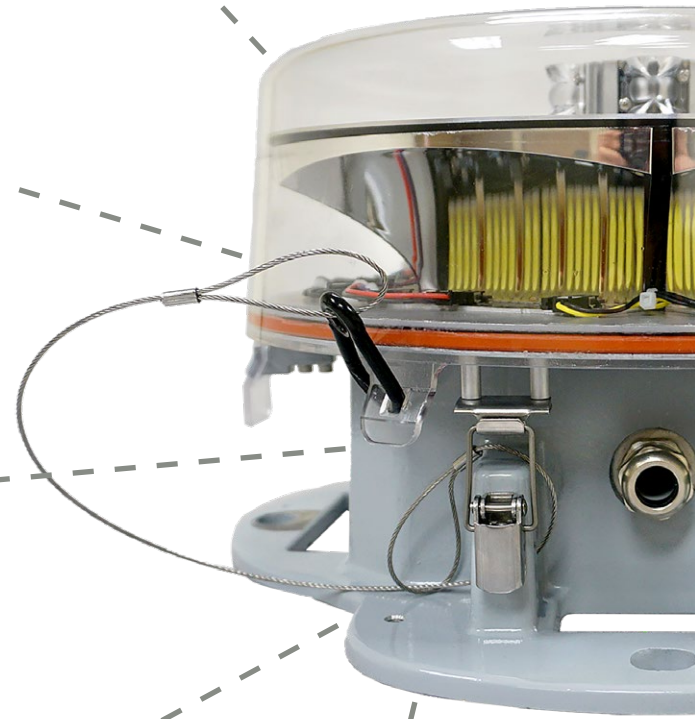

## FEATURES & BENEFITS

- Compliant to FAA Infrared (IR) standards AC 150/5345-43J and EB 98
- 5 year warranty
- Resistant to shock and vibration
- High impact polycarbonate lens with UV, scratch and chemical resistant coating
- Reduction in tower climbs for lower maintenance costs/unplanned site visits
- Community friendly lighting system utilizing patented optics

# Dialight's LED Technology Innovations Over the Years

## First ever FAA certified LED obstruction lights with IR

Vigilant® LED Based L-864/L-856 High Intensity System



2011

Current

Vigilant® LED Based L-810 Red



1999

Current

Vigilant® LED Based L-864 Red Beacon



2001

Current

Vigilant® LED Based L-864/L-865 Flashing Dual (Red/White) System



2007

Current

### Dialight Timeline

First IR enabled LED product launched in 2011, nearly 10 years before FAA regulation

1999	2001	2007	2011	2012	2013	2015	2020
• L810	• L864	• L864 / L865	• L856 • added IR to L810	• L864 / L856	• added IR to L864	• added IR to L864 / L865	• FAA requires IR

## Table of Contents

●	<b>High Intensity Products</b>	
	Vigilant® D366 LED High Intensity System L-864/L-865	4–5
●	<b>Medium Intensity Products</b>	
	Vigilant® D1CW LED Medium Intensity System L-864/L-865	6–8
	Vigilant® D5C LED Medium Intensity L-864	9–10
●	<b>Low Intensity Products</b>	
	Vigilant® RTO LED Low Intensity L-810	11

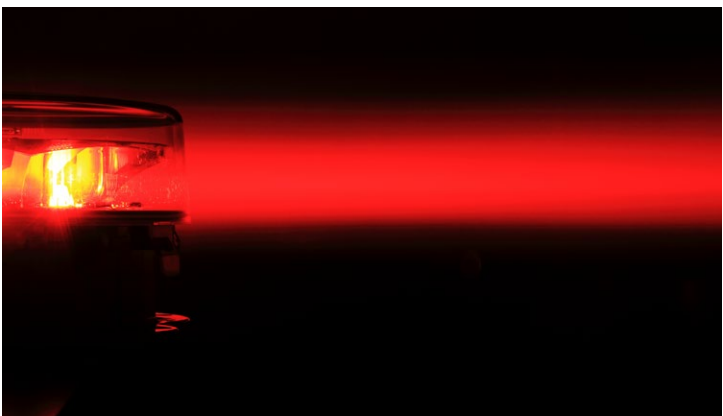

### Patented Optics

Minimum ground scatter for a “community-friendly” lighting system

Dialight (LSE: DIA.L) is leading the energy efficient LED lighting revolution around the world for industrial and hazardous areas as well as for transportation and infrastructure applications. For 40 years we have been committed to the development of LED lighting solutions that enable organizations to vastly reduce energy use and maintenance needs, improve safety, ease disposal and reduce CO2 emissions.

# Vigilant® LED High Intensity System L-864 / L-856

## High Intensity (Red / White) System with Infrared (IR)

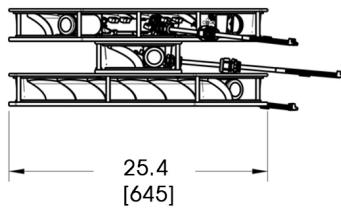
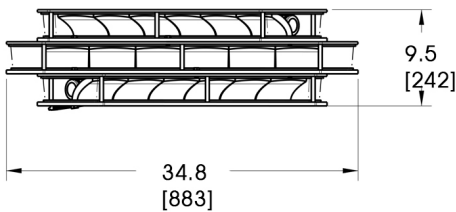
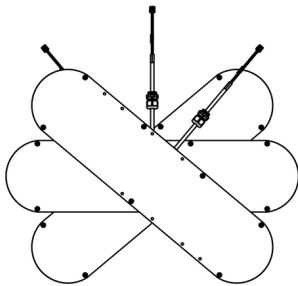

Dimensions in inches [mm]

### Certifications & Compliance

- FAA AC 150/5345 - 43J\*
- FAA EB No. 67D and 98
- IP66
- Transport Canada Car 621.19
- ICAO Annex 14
- NEMA 4X

### Features & Benefits

- 5 year warranty
- ETL verified to FAA standards\*
- IR wavelength at 850 nm
- Superior surge and lightning protection
- Controller can be mounted at the base of the structure
- IP66/NEMA 4X outdoor rated enclosures
- Low power consumption
- IP66 rated light fixtures
- Impact and vibration resistant
- Provision for padlock on the enclosure
- Patented optics for minimal down light/ground scatter
- Dry contacts for alarm monitoring/status
  - › Photocell alarm
  - › Sync alarm
  - › White mode alarm
  - › Red mode alarm
  - › Communication
  - › Operation mode (day/night)
  - › Power fail

### Technical Information:

<b>Flash head weight:</b>	63 lbs (30 kg)
<b>Operating voltage:</b>	208–277 VAC 50/60 Hz
<b>Effective intensity:</b>	White Day - 270,000 cd White Twilight - 20,000 cd White Night - 2,000 cd Red - 2,000 cd IR - 246 mW/sr
<b>Wattage:</b>	White Day - 220 W White Twilight - 40 W White Night - 30 W Red/IR - 33 W
<b>Power factor:</b>	> 0.9
<b>Ambient temperature:</b>	-40 °F to +131 °F (-40 °C to +55 °C)
<b>Synchronization:</b>	Multiple unit sync from single controller
All values typical unless otherwise stated (tolerance ± 10%)	

US Patents: #7,281,821 | #9,423,086 | #9,581,309 (other patents pending)

Part Number	Description	Voltage	Certification/Compliance
D366-A57-270	Flash head (120°) and power supply	208–277 VAC	FAA/TC/ICAO
D366-A57-CTRAC	Base controller w/ display	208–277 VAC	FAA/TC/ICAO
D366-A57-CTRACN	Base controller w/ display and integrated INEM	208–277 VAC	FAA/TC/ICAO
D256-6000-PEC	Day/Twilight/Night photocell w/ enclosure and 3/4 inch conduit entry	—	FAA/TC/ICAO
D1CW-KIT-AOL	Aviation obstruction light (AOL) & power supply kit for FAA, Types C & F	208–277 VAC	FAA/TC/ICAO

\*Certification pending  
Intertek verified FAA compliant system number D366A57SYS (system number not for order)

# Vigilant® LED High Intensity System L-864 / L-856

## High Intensity (Red / White) System with Infrared (IR)

### FAA Type B, C, F & G

#### Application

The Dialight Vigilant® High Intensity Red/White System is the first all LED L-864 / L-856 unit designed for the lighting of communication towers, chimneys, smoke stacks, broadcast towers and other tall obstructions to aerial navigation, as specified by the FAA and ICAO.

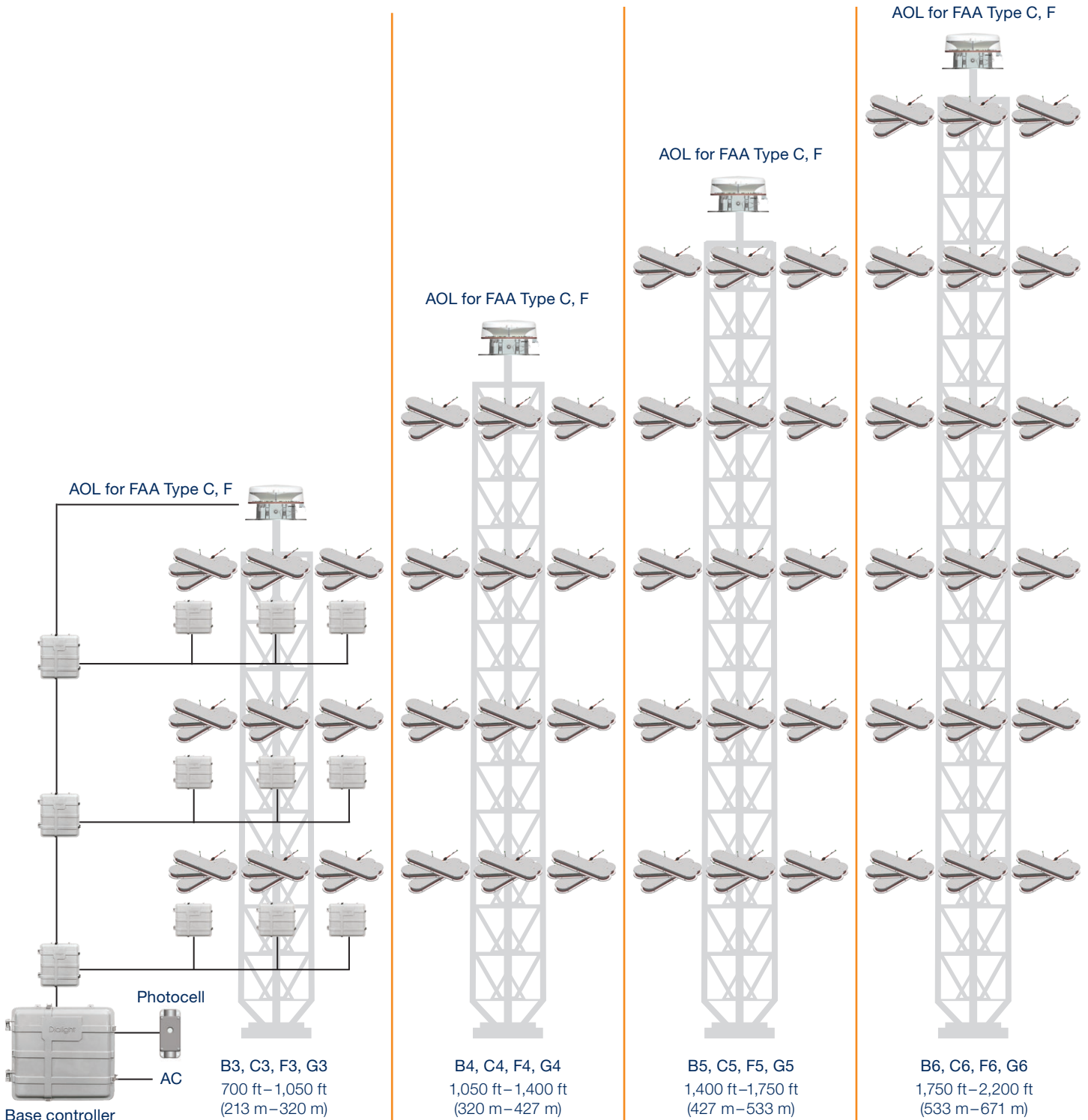

# Vigilant® LED Medium Intensity System L-864 / L-865

## Medium Intensity (Red / White) System with Infrared (IR)

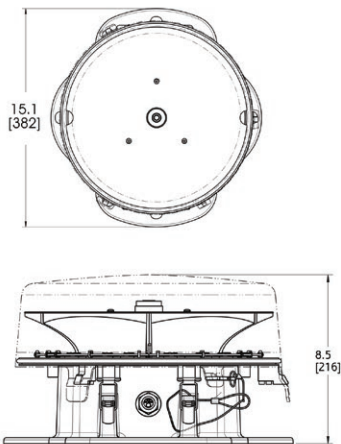

Dimensions in inches [mm]

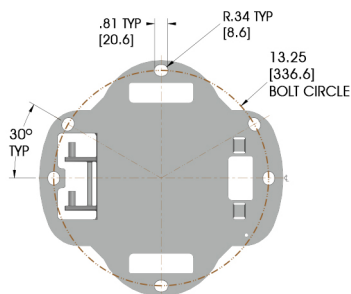

Flip top design for simple installation

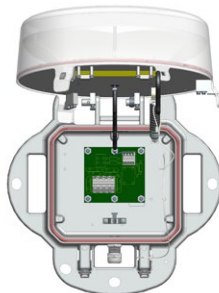

### Certifications & Compliance

- FAA AC 150/5345 - 43J
- FAA EB No. 67D and 98
- IP66
- Transport Canada Car 621.19
- ICAO Annex 14
- NEMA 4X

### Features & Benefits

- 5 year warranty
- ETL verified to FAA standards
- IR wavelength at 850 nm
- Superior surge and lightning protection
- Patented optics for minimal down light / ground scatter
- Remote monitoring options available
- Integrated controller with LCD backlit display
- Universal 120–277 VAC input or 48 VDC input
- IP66/NEMA 4X outdoor rated enclosure
- GPS synchronized controller available
- Provisions for padlock on the enclosure

### Cable

- Recommended UV rated 4 conductor cable with metal foil and braid. 14AWG (2.08 mm<sup>2</sup>) for lengths up to 680' (207 m) or 12AWG (3.31 mm<sup>2</sup>) for lengths above 680' (207 m).
- Complete kits available: D1, E1, E1+1, E2, D2, E2+1 and D2+1

### Technical Information:

<b>Flash head weight:</b>	21 lbs (9.5 kg)
<b>Operating voltage:</b>	120-277 VAC 50/60 Hz or 48 VDC power factor corrected supply
<b>Supply voltage ranges:</b>	Nominal ± 10%
<b>Effective intensity:</b>	White Day - 20,000 cd White Night - 2,000 cd Red Night - 2,000 cd IR - 246 mW/sr
<b>Flash head power:</b>	White Day - 36 W (system = 75 w) White Night - 4 W (system = 10 w) Red/IR Night - 15 W (system = 28 w)
<b>Power factor:</b>	> 0.9
<b>Operating temperature:</b>	-40 °F to +131 °F (-40 °C to +55 °C)
<b>Synchronization:</b>	Multiple unit sync from single controller
All values typical unless otherwise stated (tolerance ± 10%)	

US Patents: #7,208,881 | #7,568,821 | #7,604,380 | #7,777,424 | #9,423,086 | #9,476,548 | #9,581,309



# Vigilant® LED Medium Intensity System L-864 / L-865

## Medium Intensity (Red / White) System with Infrared (IR)

### FAA Type D & E

#### Application

Dialight's LED based dual (Red/White) obstruction system is ideal for D & E style FAA communication tower types and can be used to mark other structures as well. The operation of the lights is configurable and fully monitored. The side markers can be run in steady burn or flashing mode. The lights are ETL verified to the FAA requirements.

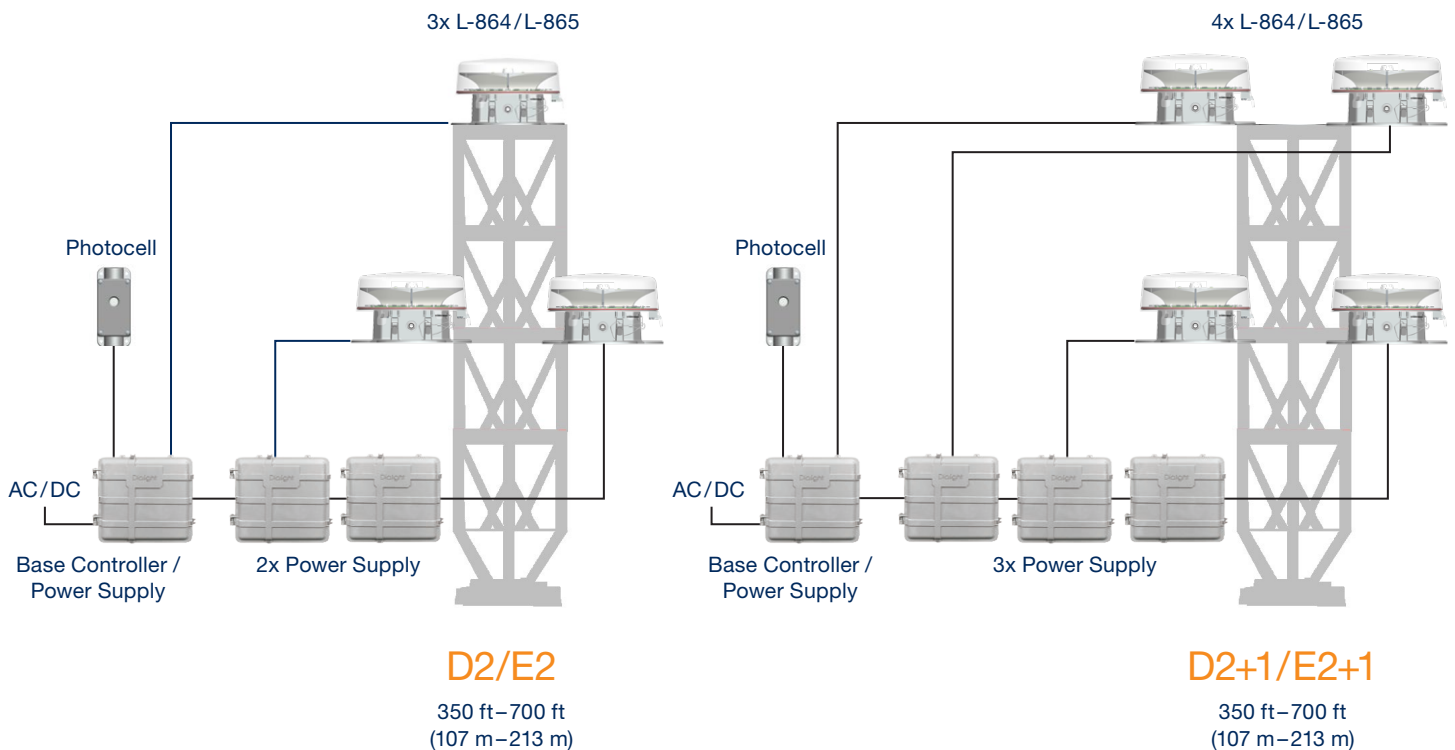
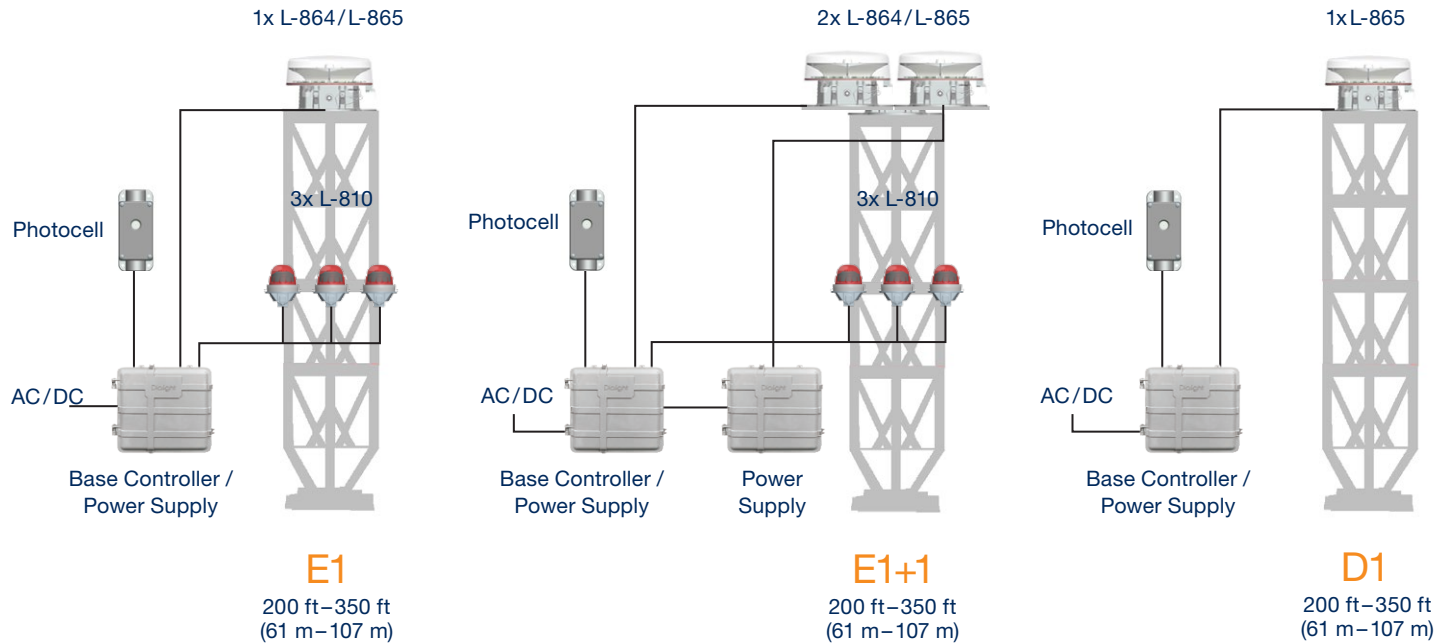

# Vigilant® LED Medium Intensity System L-864 / L-865

## Medium Intensity (Red / White) System with Infrared (IR)

### LED Flash Head (L-864 / L-865)

Part Number	Description
D1CWFH409	Dual Red/White Medium Intensity Flash Head w/ IR*

### LED Side Markers L-810

Input	Part Number	Description
12-48 VDC	RTOCR28001	L-810 Low Intensity Side Marker w/ IR: DC Input*

### Controllers

Input	Part Number	Description
120-277 VAC	D1CWCTR409	Dual Red/White Medium Intensity Controller w/ IR: AC Input
48 VDC	D1CWCTR449	Dual Red/White Medium Intensity Controller w/ IR: DC Input

### Power Supply

Input	Part Number	Description
120-277 VAC	D1CWPS9409	Dual Red/White Medium Intensity Power Supply w/ IR: AC Input
48 VDC	D1CWPS9449	Dual Red/White Medium Intensity Power Supply w/ IR: DC Input

### Photocell

Part Number	Description
D2566000PEC	Photocell: Single 3/4" NPT Entry

### Cable

Tower Height	Description
up to 680ft (207m)	14AWG (2.08mm <sup>2</sup> ) UV rated 4 conductor cable with metal foil and braid
above 680ft (207m)	12AWG (3.31mm <sup>2</sup> ) UV rated 4 conductor cable with metal foil and braid

\*Compliant to FAA Engineering Brief 98 and FAA AC 150/5345 - 43J

\*\* Intertek verified FAA compliant system numbers D1CW1x409SYS (System numbers not for order).

# Vigilant® LED Based L-864

## Medium Intensity (Red) Flash head with Infrared (IR)

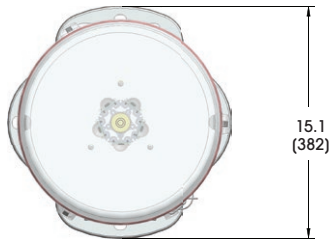
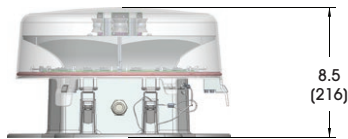
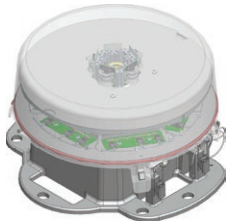

Dimensions in inches [mm]

### Certifications & Compliance

- FAA AC 150/5345 - 43J\*
- FAA EB No. 67D and 98
- IP66
- Transport Canada Car 621.19
- ICAO Annex 14
- NEMA 4X

### Features & Benefits

- 5 year warranty
- ETL verified to FAA standards\*
- IR wavelength at 850 nm
- Superior surge and lightning protection
- Patented optics for minimal down light/ground scatter
- IP66/NEMA 4X outdoor rated enclosures
- Remote monitoring options available
- Provisions for padlock on the enclosure
- 6kV of surge protection
- Shock and vibration resistant

### Technical Information:

<b>Flash head weight:</b>	18 lbs (8.2 kg)
<b>Flash rate:</b>	20, 30, or 40 (±1%)
<b>Effective intensity:</b>	Red - 2,000 cd IR - 246 mW/sr
<b>Wattage:</b>	7.0 W (16.7% duty cycle) - IR models 20 flashes per minute with 0.5 sec. on time
<b>Operating temperature:</b>	-40 °F to +131 °F (-40 °C to +55 °C)
<b>Power factor:</b>	> 0.9
All values typical unless otherwise stated (tolerance ±10%)	

US Patents: # 7,281,821 | #7,568,821 | #9,423,086 | #9,423,086 | #9,476,548  
#9,581,309 (other patents pending)

Part Number	Description	Notes	Certification / Compliance
<b>Standard Models</b>			
D664R13001	L-864 Red Flash head with IR AC	120–240 VAC	FAA (TC) L-864
D664R54001	L-864 Red Flash head with IR DC	24–48 VDC	FAA (TC) L-864
RTOCR27001	L-810 Low Intensity Side Marker - single with IR	120–240 VAC	FAA (TC) L-810
RTOCR27002	L-810 Low Intensity Side Marker - double with IR	120–240 VAC	FAA (TC) L-810
RTOCR28001	L-810 Low Intensity Side Marker - single with IR	12–48 VDC	FAA (TC) L-810
RTOCR28002	L-810 Low Intensity Side Marker - double with IR	12–48 VDC	FAA (TC) L-810
<b>Photocell</b>			
D2566000PEC	Photocell: Single 3/4" NPT Entry	—	—
<b>Controllers</b>			
D5RB55CCTR	A0/A1 Red Controller (24-48 VDC)	2 outputs	FAA (TC) L-864/L-810
D5RB77CCTR	A0/A1 Red Controller (AC system)	2 outputs	FAA (TC) L-864/L-810
D5RE77CCTR	A2-A3 Non-Avian (A2-A6 Avian) Red Controller (AC system)	12 outputs	FAA (TC) L-864/L-810
D5RG77CCTR	A2-A6 Avian or Non-Avian Red Controller (AC system)	18 outputs	FAA (TC) L-864/L-810

\*Certification pending

Intertek verified FAA compliant system numbers D6R1x0xSYS (System numbers not for order)

# Vigilant® LED Based L-810/L-864

Red-Only Medium and Low Intensity Systems with Infrared (IR)

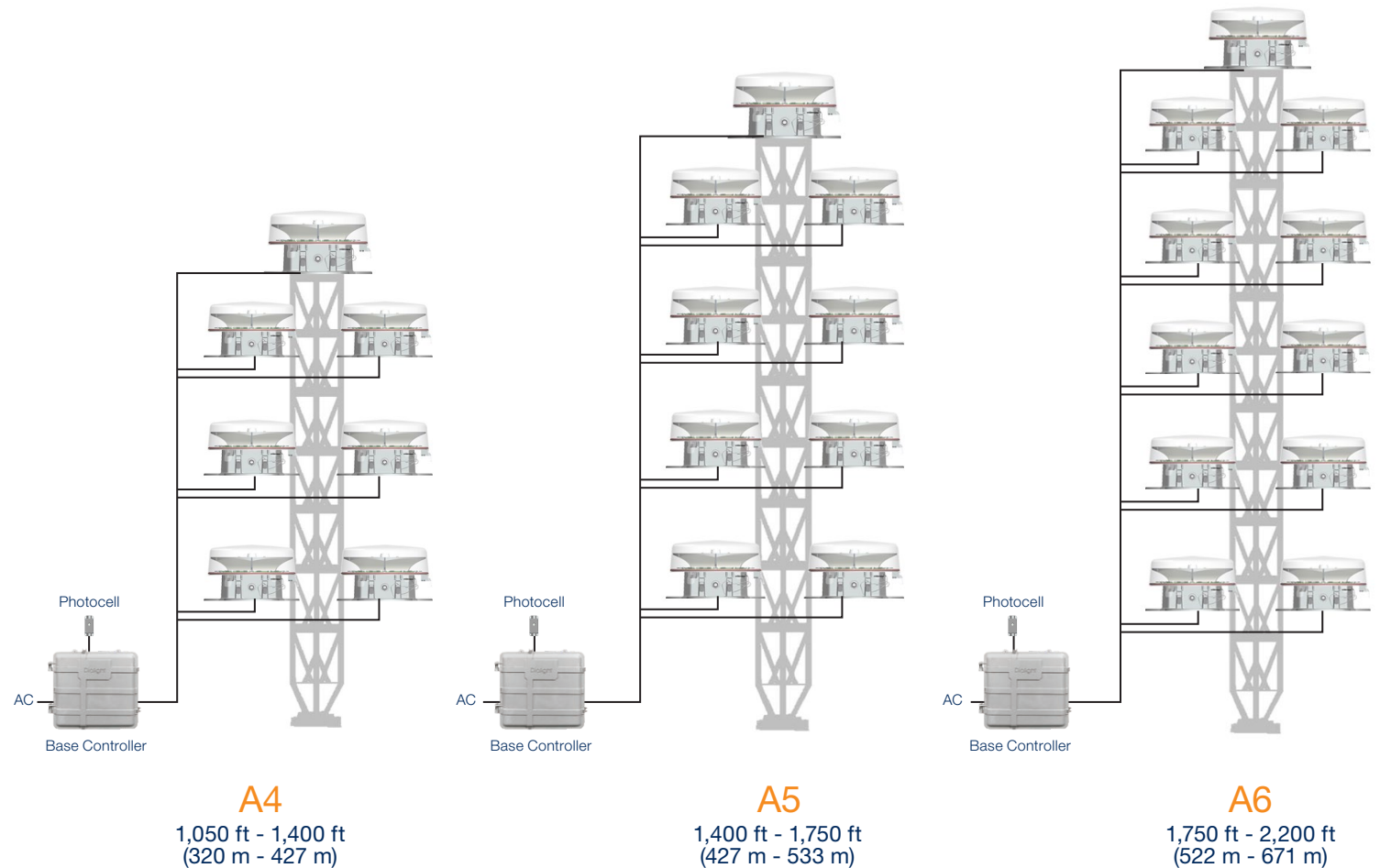
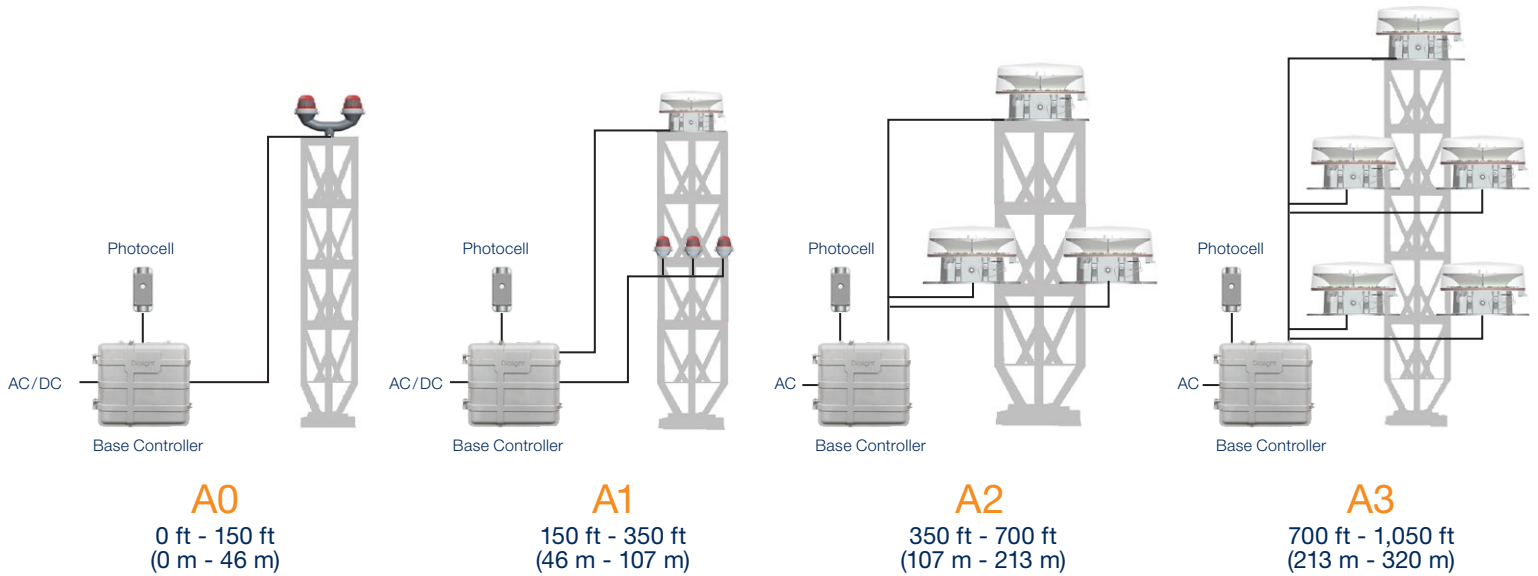

# Vigilant® LED Based L-810

## Low Intensity (Red) RTO Side Marker with Infrared (IR)

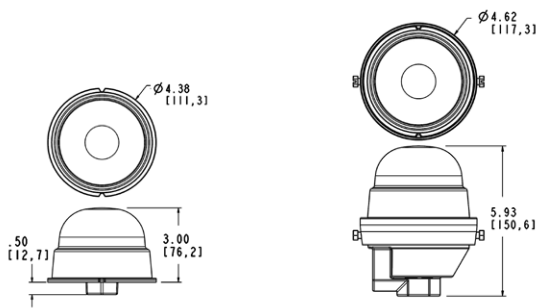
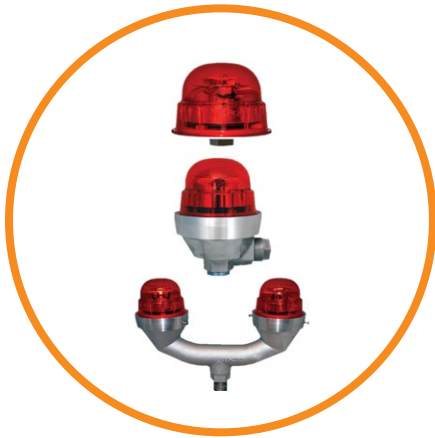

Retro-fit Unit

Single Fixture

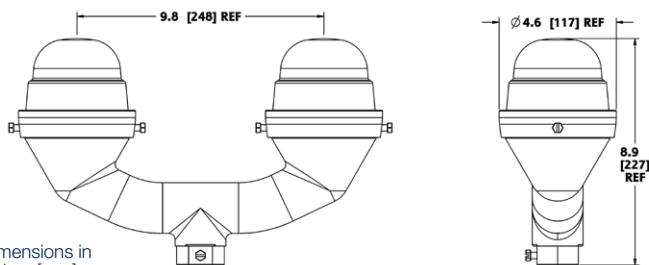

Dimensions in inches [mm]

Dual Fixture

### Certifications & Compliance

- FAA AC 150/5345 - 43J\*
- FAA EB No. 67D and 98
- IP66
- Transport Canada Car 621.19
- ICAO Annex 14
- NEMA 4X

### Features & Benefits

- 5 Year Warranty
- ETL verified to FAA standards\*
- IR wavelength at 850 nm
- Superior surge and lightning protection
- Controllers available for all applications
- Compact, low power design
- Ideal for towers, stacks, wind turbines, buildings, etc.
- 360 degree coverage for each flash head
- Shock and vibration resistant
- Lighting kits available for standard towers

### Technical Information:

<b>Unit weight:</b>	1.25 lbs (0.56 kg) (Retro unit) 2.00 lbs (0.91 kg) (Single unit) 4.60 lbs (2.09 kg) (Dual unit)
<b>Supply voltage ranges:</b>	Nominal ±10%
<b>Effective intensity:</b>	Red - 32 cd IR - 4 mW/sr
<b>Power factor:</b>	> 0.9 (All AC units)
<b>Operating temperature:</b>	-40 °F to +131 °F (-40 °C to +55 °C)
<b>Input AC frequency:</b>	50/60 Hz
All values typical unless otherwise stated (tolerance ± 10%)	

US Patent #7,604,384 | # 9,423,086 | #9.423,086

Part Number	Description	Voltage	Certification / Compliance	Wattage
RTOCR27001	Single Fixture Red/Infrared (IR)	120–240 VAC	FAA (TC) L-810	5.5
RTOCR28001	Single Fixture Red/Infrared (IR)	12–48 VDC	FAA (TC) L-810	5.0
RTOCR27002	Dual Fixture Red/Infrared (IR)	120–240 VAC	FAA (TC) L-810	5.5
RTOCR28002	Dual Fixture Red/Infrared (IR)	12–48 VDC	FAA (TC) L-810	5.0
RTOCR27004	Single Side Marker Retro-fit Fixture Red/Infrared (IR)	120–240 VAC	FAA (TC) L-810	5.5
RTOCR28004	Single Side Marker Retro-fit Fixture Red/Infrared (IR)	12–48 VDC	FAA (TC) L-810	5.0

\*Certification pending

Lined area for taking notes.



**North American HQ**

1501 Route 34 South  
Farmingdale, NJ 07727  
Tel: 732-919-3119  
Fax: 732-751-5778  
info@dialight.com

**EMEA Technical Centre**

Tel: +44 1638 666541 (UK)  
Tel: +49 89 12089 5713 (Germany)  
Tel: +33 3 23 22 62 58 (France)  
sales-europe@dialight.com

**Houston**

16830 Barker Springs Rd  
Ste 407  
Houston, TX 77084  
Tel: 732-919-3119  
Fax: 281-492-1531  
info@dialight.com

**Middle East**

Level 42  
Emirates Towers (Office Tower)  
Sheikh Zayed Road  
Dubai, United Arab Emirates  
Fax: +971 (0) 4319 7686  
Tel: +971 (0) 4319 7686

**Australia**

38 O'Malley Street  
Osborne Park, WA 6017  
Tel: +61 (0) 8 9244 7600  
Fax: +61 (0) 8 9244 7601  
info@dialight.com.au

**Southeast Asia**

33 Ubi Avenue 3  
#07-72 Vertex (Tower A)  
Singapore 408868  
Tel: +65 6578 7157  
Fax: +65 6578 7150  
enquiry@dialight.com.sg

**Brazil**

Alameda Mercurio,  
225 – American Park Empresarial NR  
Indaiatuba – SP – 13347– 662  
Tel: +55 (19) 3113-4300  
Fax: +55 (19) 3113-4300  
brasil@dialight.com

All values are design or typical values when measured under laboratory conditions. The lighting efficiency statements contained herein are calculated on a lumen per watts basis when comparing fixtures with similar features. All information provided is accurate as of the date of publication, is subject to change without notice and does not form part of any contract with dialight. Dialight does not warrant or represent that its products are fit for any particular purpose and has no responsibility for the inappropriate/unauthorised/non-approved use of any Dialight products by the end user.

Dialight reserves the right to make changes at any time in order to supply the best product possible.

The most current version of this document will always be available at: [www.dialight.com](http://www.dialight.com)