

# Accessory Installation / Operating Instructions

These instructions contain safety information, read and follow them carefully. Dialight will not accept any responsibility for injury, damage or loss which may occur due to incorrect installation, operation or maintenance.

**Note: Save these instructions for future use**

**ATTENTION**

It is important to understand that by replacing the 'window' on the luminaire, this will affect the warranty of the luminaire. Dialight is not responsible for damage to the luminaire if mounted improperly.

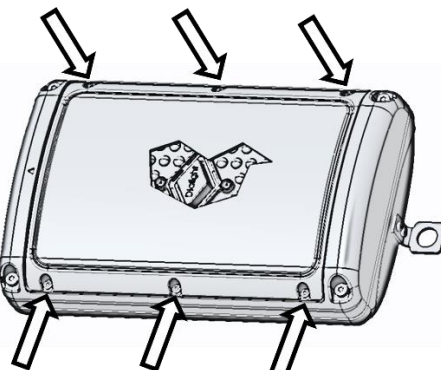
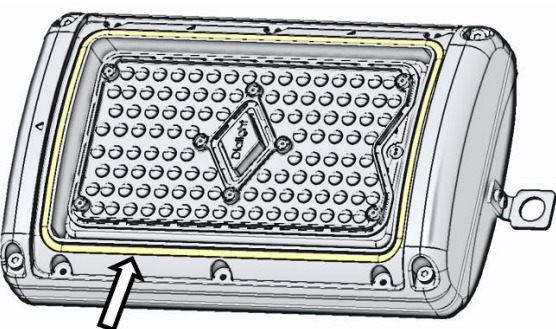
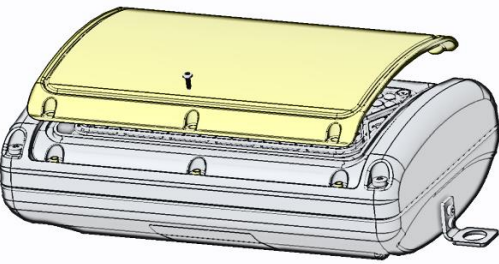
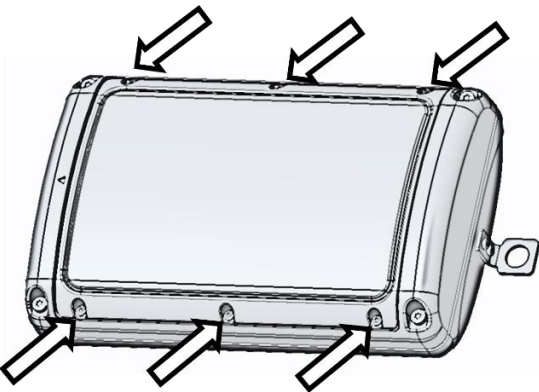
 <p>Remove the hardware of the damaged WINDOW</p>	 <p>Ensure the GASKET is not damaged <b>CAUTION: DO NOT REMOVE GASKET</b></p>
 <p>Ensure WASHER is between the WINDOW and SCREW HEAD (6 places)</p>	 <p>Torque = 4.3 N-m (38 in-lbs)</p>

**Official Statement**

All statements, technical information, and recommendations contained herein are based on information and tests that Dialight believes to be reliable. The accuracy or completeness thereof is not guaranteed. In accordance with Dialight Terms and Conditions of Sale and since conditions of use are outside our control, the purchaser should determine the suitability of the product for his or her intended use and assumes all risk and liability whatsoever in connection therewith.



# Instruksi Pemasangan/Pengoperasian Aksesori

Instruksi ini memuat informasi keamanan, baca dan ikuti dengan saksama.

Dialight tidak akan bertanggung jawab atas cedera, kerusakan, atau kerugian karena pemasangan, operasi, atau pemeliharaan yang salah.

**Catatan: Simpan instruksi ini untuk penggunaan di masa depan**

**PERHATIAN**

Penting untuk dipahami bahwa dengan mengganti 'jendela' pada luminaire, garansi luminaire akan terpengaruh. Dialight tidak bertanggung jawab atas luminaire, jika dipasang secara tidak tepat.

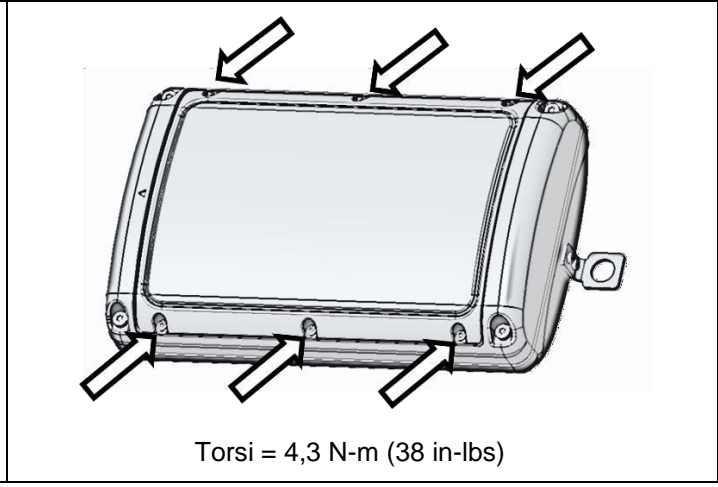
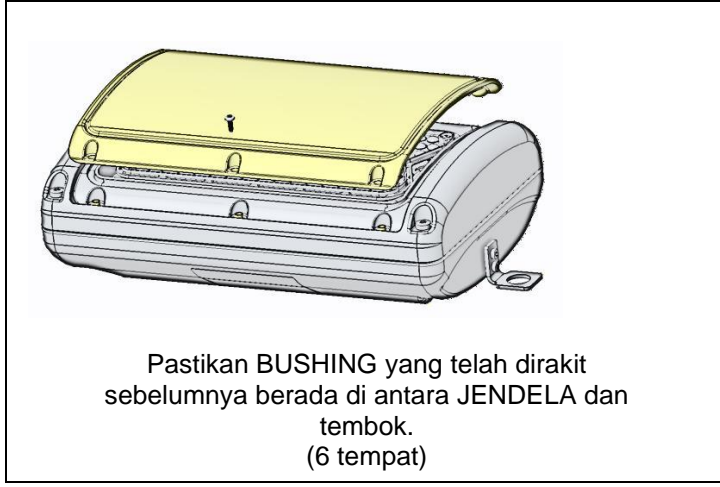
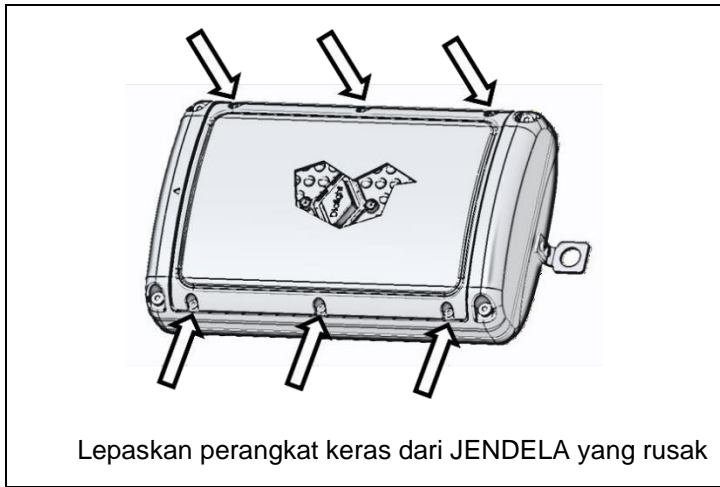

**Pernyataan Resmi**

Semua pernyataan, informasi teknis, dan rekomendasi yang termuat di dalam dokumen ini didasarkan pada informasi dan pengujian yang andal. Akurasi kelengkapan tidak dijamin. Sesuai dengan Syarat dan Ketentuan Dialight dan karena kondisi pemakaian berada di luar kendali kami, pembeli harus menentukan kesesuaian produk yang digunakan dan menanggung semua risiko dan tanggung jawab yang berhubungan dengannya.

