

# .....Dialight



## Dialight® LED Bulkhead

### Technical Specification Sheet - APAC

## Vigilant® LED Bulkhead 100-277 VAC Model



### Certifications & Ratings

- 10 year warranty
- CE / RCM
- IP66/67
- IK10
- L70 > 150,000 hours @ 65°C (149°F) ambient

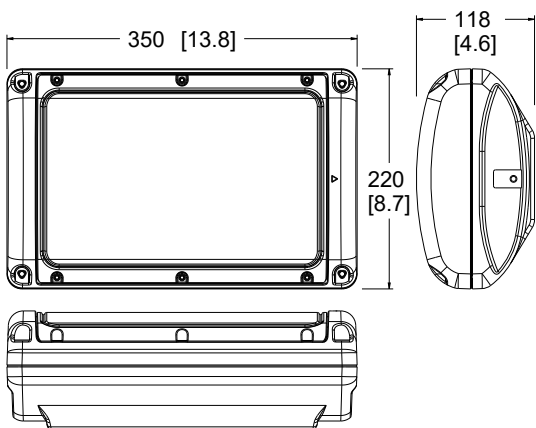

Dimensions in mm (inches)

### Mechanical Information:

#### Fixture weights:

Standard models: 6.3 kg (13.8 lb)

Battery backup models: 7.7 kg (17 lb)

#### Shipping weights:

Standard models: 7 kg (15.4 lb)

Battery backup models: 8.4 kg (18.5 lb)

#### Cable entry:

(2) M20 - optional (4) M20

### Materials:

**Housing:** A360 Die-cast aluminium

#### Finish:

Superior dual coat finish  
- Sealed polyester topcoat  
- Epoxy primer

#### Lens:

Polycarbonate clear  
Polycarbonate diffused (optional)

#### Hardware:

316 Stainless Steel

### Electrical Specifications:

#### Operating voltage:

Standard models: 100-277 VAC / 120-250 VDC

Battery backup models: 230/240 VAC

#### Operating temperature:

Standard models: -40°C to +65°C (-40°F to +149°F)

Battery backup models: -20°C to +55°C (-4°F to +131°F)

#### Surge protection:

Tested to IEC 61000-4-5  
6kV/3kA, 1.2/50, 8/20us  
Combination Wave  
Line-line and line-ground

#### THD:

< 18%

#### Power factor:

> 0.9

#### Dimming:

DALI 1.0 and 2.0  
0-10 VDC continuous dimming to <10%

### Battery Backup Models: (integral battery)

#### Battery duration\* (circular optic, clear lens):

6.5k lumen outputs: 180 mins ~ 900 lm

90 mins ~ 1100 lm

60 mins ~ 1140 lm

3k lumen outputs: 180 mins ~ 800 lm

90 mins ~ 1100 lm

60 mins ~ 1140 lm

#### Expected battery life:

4 years

### Photometric Information:

**Lumen output\*:** 3,000 & 6,500 lm (white light)

#### CRI:

> 80 (white light)

#### CCT:

5000K (cool white)

4000K (neutral white)

All values typical unless otherwise stated (tolerance +/- 10%)

\* @ 25°C ambient

**WARNING - INSTALLATION & SECONDARY RETENTION.** Use of any Dialight products without proper installation (including secondary retention / netting) and periodic inspections could cause severe injury or death. Dialight recommends that all installations should use secondary retention / netting (appropriate to the installation environment) where applicable. It is the exclusive responsibility of the contractor, installer and/or end-user to: (a) determine the suitability of the product for its intended application; and, (b) ensure that the product is safely installed (with secondary retention / netting where appropriate) and in compliance with all applicable laws and regulations. To the extent permissible under applicable laws, Dialight disclaims all liability for personal injury and/or other damage resulting from any dislodgment or other dislocation of its products.

## Ordering Information

### Vigilant® LED Bulkhead



### Australia

| Part Number                                     | Fixture Lumens | Wattage | lm/W | Voltage                   | CCT                   | Lens                | Beam Distribution   |
|---|----------------|---------|------|---------------------------|-----------------------|---------------------|---------------------|
| <b>Standard Models with Flush Bracket</b>       |                |         |      |                           |                       |                     |                     |
| <b>BHE-4BN2-3NFN-VGN</b>                        | 3,200          | 22      | 149  | 100-277 VAC / 120-250 VDC | 4000K (neutral white) | Clear Polycarbonate | Circular            |
| <b>BHE-4BN2-6NFN-VGN</b>                        | 6,700          | 45      | 149  | 100-277 VAC / 120-250 VDC | 4000K (neutral white) | Clear Polycarbonate | Circular            |
| BHE-4UN2-3NFN-VGN                               | 3,100          | 22      | 144  | 100-277 VAC / 120-250 VDC | 4000K (neutral white) | Clear Polycarbonate | Ultra-Wide (Type 1) |
| BHE-4UN2-6NFN-VGN                               | 6,400          | 45      | 142  | 100-277 VAC / 120-250 VDC | 4000K (neutral white) | Clear Polycarbonate | Ultra-Wide (Type 1) |
| <b>Battery Backup Models with Flush Bracket</b> |                |         |      |                           |                       |                     |                     |
| <b>BHE-4BNG-3NFN-VGF</b>                        | 3,200          | 25      | 128  | 230/240 VAC               | 4000K (neutral white) | Clear Polycarbonate | Circular            |
| <b>BHE-4BNG-6NFN-VGF</b>                        | 6,700          | 48      | 140  | 230/240 VAC               | 4000K (neutral white) | Clear Polycarbonate | Circular            |
| BHE-4UNG-3NFN-VGF                               | 3,100          | 25      | 124  | 230/240 VAC               | 4000K (neutral white) | Clear Polycarbonate | Ultra-Wide (Type 1) |
| BHE-4UNG-6NFN-VGF                               | 6,400          | 48      | 133  | 230/240 VAC               | 4000K (neutral white) | Clear Polycarbonate | Ultra-Wide (Type 1) |

All values typical unless otherwise stated (tolerance +/- 10%). Part numbers listed in **bold** are typically available in stock.

### Asia

| Part Number                                     | Fixture Lumens | Wattage | lm/W | Voltage                   | CCT                | Lens                | Beam Distribution   |
|---|----------------|---------|------|---------------------------|--------------------|---------------------|---------------------|
| <b>Standard Models with Flush Bracket</b>       |                |         |      |                           |                    |                     |                     |
| BHE-4BC2-3NFN-VGN                               | 3,200          | 22      | 149  | 100-277 VAC / 120-250 VDC | 5000K (cool white) | Clear Polycarbonate | Circular            |
| BHE-4BC2-6NFN-VGN                               | 6,700          | 45      | 149  | 100-277 VAC / 120-250 VDC | 5000K (cool white) | Clear Polycarbonate | Circular            |
| BHE-4UC2-3NFN-VGN                               | 3,100          | 22      | 144  | 100-277 VAC / 120-250 VDC | 5000K (cool white) | Clear Polycarbonate | Ultra-Wide (Type 1) |
| BHE-4UC2-6NFN-VGN                               | 6,400          | 45      | 142  | 100-277 VAC / 120-250 VDC | 5000K (cool white) | Clear Polycarbonate | Ultra-Wide (Type 1) |
| <b>Battery Backup Models with Flush Bracket</b> |                |         |      |                           |                    |                     |                     |
| BHE-4BCG-3NFN-VGG                               | 3,200          | 25      | 128  | 230/240 VAC               | 5000K (cool white) | Clear Polycarbonate | Circular            |
| BHE-4BCG-6NFN-VGG                               | 6,700          | 48      | 140  | 230/240 VAC               | 5000K (cool white) | Clear Polycarbonate | Circular            |
| BHE-4UCG-3NFN-VGG                               | 3,100          | 25      | 124  | 230/240 VAC               | 5000K (cool white) | Clear Polycarbonate | Ultra-Wide (Type 1) |
| BHE-4UCG-6NFN-VGG                               | 6,400          | 48      | 133  | 230/240 VAC               | 5000K (cool white) | Clear Polycarbonate | Ultra-Wide (Type 1) |

All values typical unless otherwise stated (tolerance +/- 10%).

**DISCLAIMER.** All product information provided is, to the best of Dialight's knowledge, accurate as of the date of publication. When ordering, refer to [www.dialight.com](http://www.dialight.com) for current versions of: (a) relevant product documentation (including the relevant product data sheets); (b) Dialight terms and conditions of sale; and, (c) the relevant product warranty. To the extent that any contract is deemed formed between Dialight and the purchaser of Dialight products and/or an end-user, versions of documents available at [www.dialight.com](http://www.dialight.com) as at the date of sale shall be the versions incorporated therein. In the event of any discrepancy between this document or information provided at [www.dialight.com](http://www.dialight.com), the latter shall prevail.

### Vigilant® LED Bulkhead Pole Mount Model



#### Certifications & Ratings

- 10 year warranty
- CE / RCM
- IP66/67
- IK10
- L70 > 150,000 hours @ 65°C (149°F) ambient

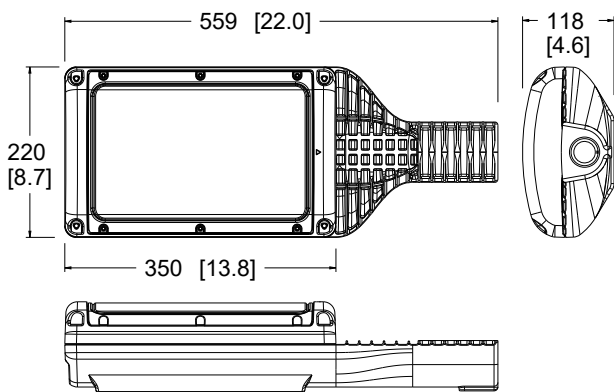

Dimensions in mm (inches)

#### Mechanical Information:

|                           |                  |
|---------------------------|------------------|
| <b>Fixture weights:</b>   |                  |
| Standard models:          | 8.1 kg (17.9 lb) |
| Battery backup models:    | 9 kg (19.7 lb)   |
| <b>Shipping weights:</b>  |                  |
| Standard models:          | 8.8 kg (19.4 lb) |
| Battery backup models:    | 9.7 kg (20.4 lb) |
| <b>Cable entry:</b>       | (1) M25          |
| <b>Spigot entry size:</b> | 35mm ID          |

#### Materials:

|                  |   |
|------------------|---|
| <b>Housing:</b>  | A360 Die-cast aluminium   |
| <b>Finish:</b>   | Superior dual coat finish<br>- Sealed polyester topcoat<br>- Epoxy primer |
| <b>Lens:</b>     | Polycarbonate clear<br>Polycarbonate diffused (optional)                  |
| <b>Hardware:</b> | 316 Stainless Steel   |

#### Electrical Specifications:

|                               |   |
|-------------------------------|---|
| <b>Operating voltage:</b>     |   |
| Standard models:              | 100-277 VAC / 120-250 VDC   |
| Battery backup models:        | 230/240 VAC   |
| <b>Operating temperature:</b> |   |
| Standard models:              | -40°C to +65°C (-40°F to +149°F)  |
| Battery backup models:        | -20°C to +55°C (-4°F to +131°F)   |
| <b>Surge protection:</b>      | Tested to IEC 61000-4-5<br>6kV/3kA, 1.2/50, 8/20us<br>Combination Wave<br>Line-line and line-ground |
| <b>THD:</b>                   | < 18%   |
| <b>Power factor:</b>          | > 0.9   |
| <b>Dimming:</b>               | DALI 1.0 and 2.0<br>0-10 VDC continuous dimming to <10%   |

#### Battery Backup Models: (integral battery)

|  |   |
|--|---|
| <b>Battery duration* (circular optic, clear lens):</b> |   |
| 6.5k lumen outputs:                                    | 180 mins ~ 900 lm<br>90 mins ~ 1100 lm<br>60 mins ~ 1140 lm |
| 3k lumen outputs:                                      | 180 mins ~ 800 lm<br>90 mins ~ 1100 lm<br>60 mins ~ 1140 lm |

**Expected battery life:** 4 years

#### Photometric Information:

|                       |   |
|-----------------------|---|
| <b>Lumen output*:</b> | 3,000 & 6,500 lm (white light)              |
| <b>CRI:</b>           | > 80 (white light)                          |
| <b>CCT:</b>           | 5000K (cool white)<br>4000K (neutral white) |

All values typical unless otherwise stated (tolerance +/- 10%)  
\* @ 25°C ambient

**WARNING - INSTALLATION & SECONDARY RETENTION.** Use of any Dialight products without proper installation (including secondary retention / netting) and periodic inspections could cause severe injury or death. Dialight recommends that all installations should use secondary retention / netting (appropriate to the installation environment) where applicable. It is the exclusive responsibility of the contractor, installer and/or end-user to: (a) determine the suitability of the product for its intended application; and, (b) ensure that the product is safely installed (with secondary retention / netting where appropriate) and in compliance with all applicable laws and regulations. To the extent permissible under applicable laws, Dialight disclaims all liability for personal injury and/or other damage resulting from any dislodgment or other dislocation of its products.

# Ordering Information

## Vigilant® LED Bulkhead - Pole Mount Model



### Australia

| Part Number                             | Fixture Lumens | Wattage | lm/W | Voltage                   | CCT                   | Lens                | Beam Distribution   |
|---|----------------|---------|------|---------------------------|-----------------------|---------------------|---------------------|
| <b>Pole Mount Models</b>                |                |         |      |                           |                       |                     |                     |
| BPE-4BN2-3NNN-VGN                       | 3,200          | 22      | 149  | 100-277 VAC / 120-250 VDC | 4000K (neutral white) | Clear Polycarbonate | Circular            |
| BPE-4BN2-6NNN-VGN                       | 6,700          | 45      | 149  | 100-277 VAC / 120-250 VDC | 4000K (neutral white) | Clear Polycarbonate | Circular            |
| <b>BPE-4UN2-3NNN-VGN</b>                | 3,100          | 22      | 144  | 100-277 VAC / 120-250 VDC | 4000K (neutral white) | Clear Polycarbonate | Ultra-Wide (Type 1) |
| <b>BPE-4UN2-6NNN-VGN</b>                | 6,400          | 45      | 142  | 100-277 VAC / 120-250 VDC | 4000K (neutral white) | Clear Polycarbonate | Ultra-Wide (Type 1) |
| <b>Pole Mount Battery Backup Models</b> |                |         |      |                           |                       |                     |                     |
| BPE-4BNG-3NNN-VGF                       | 3,200          | 25      | 128  | 230/240 VAC               | 4000K (neutral white) | Clear Polycarbonate | Circular            |
| BPE-4BNG-6NNN-VGF                       | 6,700          | 48      | 140  | 230/240 VAC               | 4000K (neutral white) | Clear Polycarbonate | Circular            |
| <b>BPE-4UNG-3NNN-VGF</b>                | 3,100          | 25      | 124  | 230/240 VAC               | 4000K (neutral white) | Clear Polycarbonate | Ultra-Wide (Type 1) |
| <b>BPE-4UNG-6NNN-VGF</b>                | 6,400          | 48      | 133  | 230/240 VAC               | 4000K (neutral white) | Clear Polycarbonate | Ultra-Wide (Type 1) |

All values typical unless otherwise stated (tolerance +/- 10%).  
Part numbers listed in **bold** are typically available in stock.

### Asia

| Part Number                             | Fixture Lumens | Wattage | lm/W | Voltage                   | CCT                | Lens                | Beam Distribution   |
|---|----------------|---------|------|---------------------------|--------------------|---------------------|---------------------|
| <b>Pole Mount Models</b>                |                |         |      |                           |                    |                     |                     |
| BPE-4BC2-3NNN-VGN                       | 3,200          | 22      | 149  | 100-277 VAC / 120-250 VDC | 5000K (cool white) | Clear Polycarbonate | Circular            |
| BPE-4BC2-6NNN-VGN                       | 6,700          | 45      | 149  | 100-277 VAC / 120-250 VDC | 5000K (cool white) | Clear Polycarbonate | Circular            |
| BPE-4UC2-3NNN-VGN                       | 3,100          | 22      | 144  | 100-277 VAC / 120-250 VDC | 5000K (cool white) | Clear Polycarbonate | Ultra-Wide (Type 1) |
| BPE-4UC2-6NNN-VGN                       | 6,400          | 45      | 142  | 100-277 VAC / 120-250 VDC | 5000K (cool white) | Clear Polycarbonate | Ultra-Wide (Type 1) |
| <b>Pole Mount Battery Backup Models</b> |                |         |      |                           |                    |                     |                     |
| BPE-4BCG-3NNN-VGG                       | 3,200          | 25      | 128  | 230/240 VAC               | 5000K (cool white) | Clear Polycarbonate | Circular            |
| BPE-4BCG-6NNN-VGG                       | 6,700          | 48      | 140  | 230/240 VAC               | 5000K (cool white) | Clear Polycarbonate | Circular            |
| BPE-4UCG-3NNN-VGG                       | 3,100          | 25      | 124  | 230/240 VAC               | 5000K (cool white) | Clear Polycarbonate | Ultra-Wide (Type 1) |
| BPE-4UCG-6NNN-VGG                       | 6,400          | 48      | 133  | 230/240 VAC               | 5000K (cool white) | Clear Polycarbonate | Ultra-Wide (Type 1) |

All values typical unless otherwise stated (tolerance +/- 10%).

**DISCLAIMER.** All product information provided is, to the best of Dialight's knowledge, accurate as of the date of publication. When ordering, refer to [www.dialight.com](http://www.dialight.com) for current versions of: (a) relevant product documentation (including the relevant product data sheets); (b) Dialight terms and conditions of sale; and, (c) the relevant product warranty. To the extent that any contract is deemed formed between Dialight and the purchaser of Dialight products and/or an end-user, versions of documents available at [www.dialight.com](http://www.dialight.com) as at the date of sale shall be the versions incorporated therein. In the event of any discrepancy between this document or information provided at [www.dialight.com](http://www.dialight.com), the latter shall prevail.

# Accessories

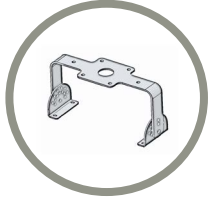

**BH-BRKT-SS-ADJ**

- 316 stainless steel adjustable bracket kit

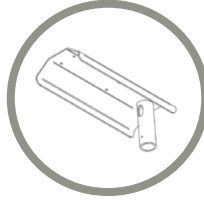

**BH-STMB-05-10-HD**

- Aluminium stanchion mount, 5° up-tilt - 50mm pole

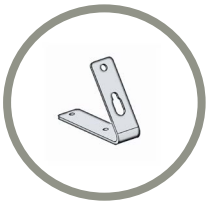

**BH-BRKT-A-KIT**

- 316 stainless steel wall/ceiling flush mount bracket kit

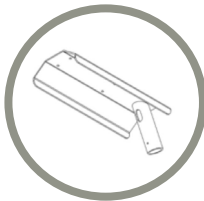

**BH-STMB-25-10-HD**

- Aluminium stanchion mount, 25° up-tilt - 50mm pole

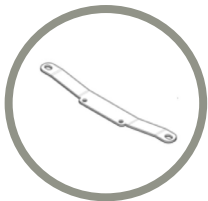

**BH-BRKT-F-KIT**

- 316 stainless steel wall/ceiling flush mount bracket kit

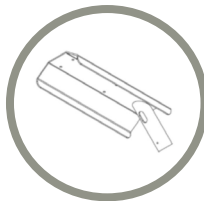

**BH-STMB-45-10-HD**

- Aluminium stanchion mount, 45° up-tilt - 50mm pole

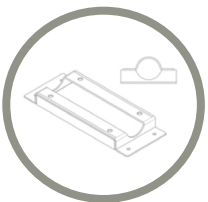

**BH-BRKT-LG-PF**

- Aluminium pipe mount bracket kit - 50mm

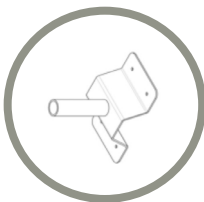

**HZG-SPIGOT-34**

- Aluminium wall mount spigot plate - 34mm



**H6XCAB72**

- 72" stainless steel safety rope



# Beam Distribution

Ultra-Wide Walkway (Type 1) - Clear

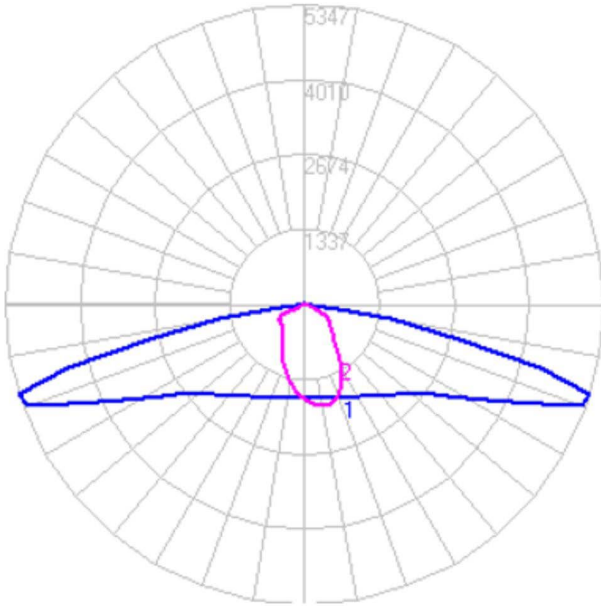

Circular - Clear

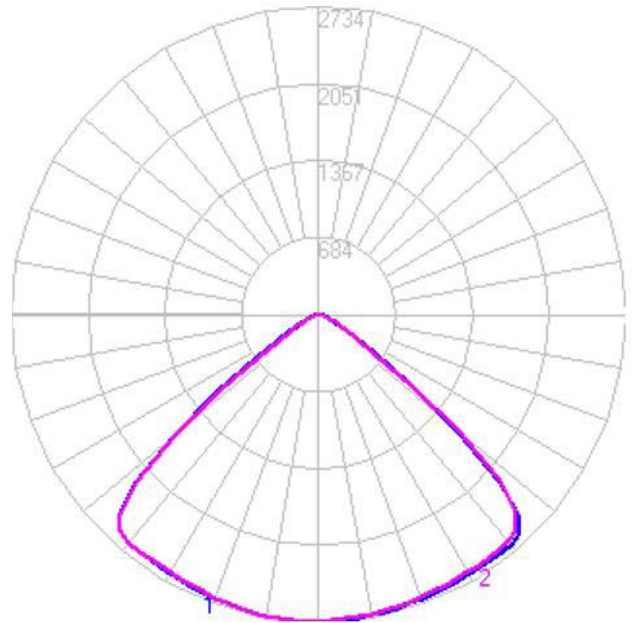

Ultra-Wide Walkway (Type 1) - Diffused

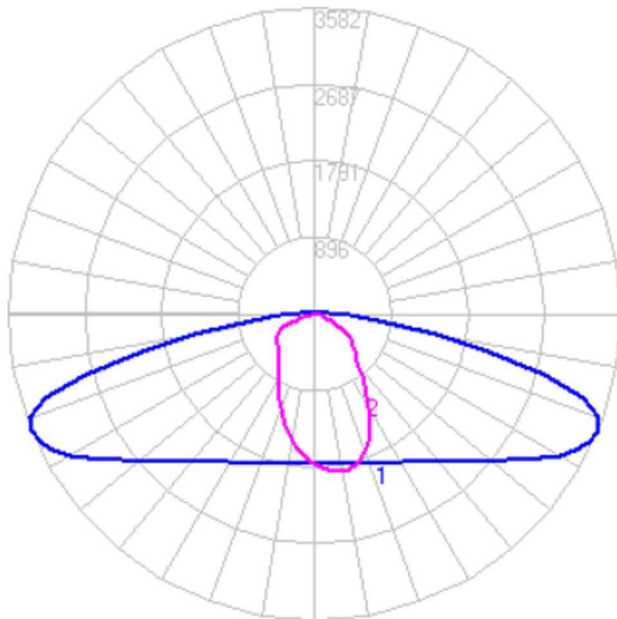

Circular - Diffused

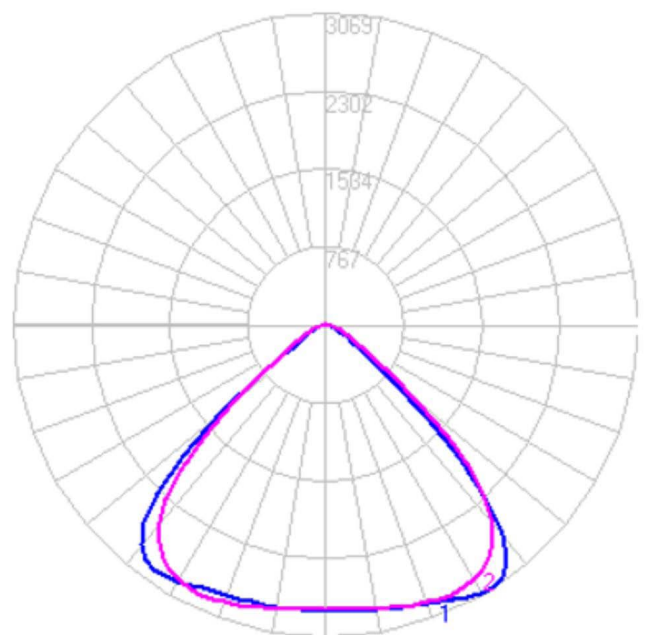

DISCLAIMER. All product information provided is, to the best of Dialight's knowledge, accurate as of the date of publication. When ordering, refer to [www.dialight.com](http://www.dialight.com) for current versions of: (a) relevant product documentation (including the relevant product data sheets); (b) Dialight terms and conditions of sale; and, (c) the relevant product warranty. To the extent that any contract is deemed formed between Dialight and the purchaser of Dialight products and/or an end-user, versions of documents available at [www.dialight.com](http://www.dialight.com) as at the date of sale shall be the versions incorporated therein. In the event of any discrepancy between this document or information provided at [www.dialight.com](http://www.dialight.com), the latter shall prevail.

## Thermal Roll-Off

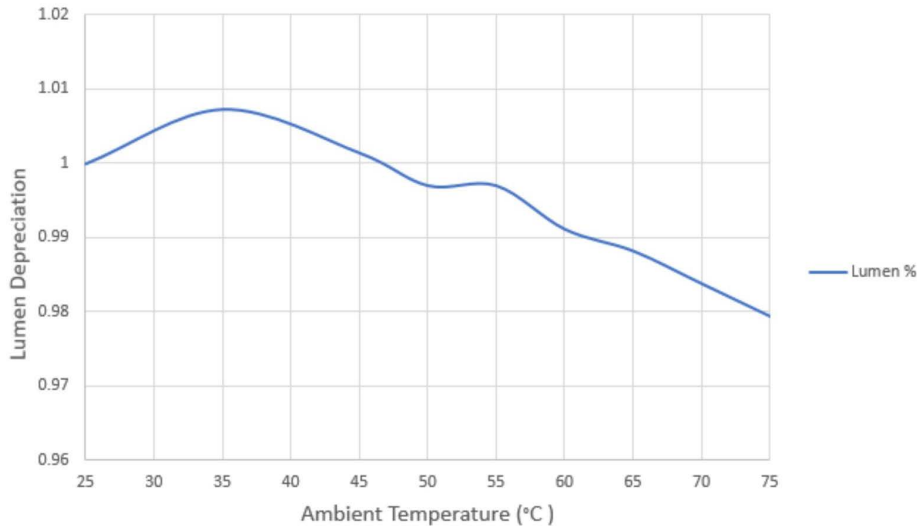

## Inrush Current / Circuit Breakers

| Output | In rush (A) current @ input voltage |               |         |               |         |               |         |               |
|--------|-------------------------------------|---------------|---------|---------------|---------|---------------|---------|---------------|
|        | 100 VAC                             | Duration (MS) | 120 VAC | Duration (MS) | 230 VAC | Duration (MS) | 277 VAC | Duration (MS) |
| 6,500  | 6                                   | 0.6           | 8       | 0.6           | 15      | 0.6           | 18      | 0.6           |
| 3,000  | 6                                   | 0.6           | 8       | 0.6           | 15      | 0.6           | 18      | 0.6           |

| Output | GND Leakage (mA) input voltage |         |         |         |
|--------|--------------------------------|---------|---------|---------|
|        | 100 VAC                        | 120 VAC | 230 VAC | 277 VAC |
| 6,500  | 0.5                            | 0.5     | 0.8     | 1.0     |
| 3,000  | 0.5                            | 0.5     | 0.8     | 1.0     |

**DISCLAIMER.** All product information provided is, to the best of Dialight's knowledge, accurate as of the date of publication. When ordering, refer to [www.dialight.com](http://www.dialight.com) for current versions of: (a) relevant product documentation (including the relevant product data sheets); (b) Dialight terms and conditions of sale; and, (c) the relevant product warranty. To the extent that any contract is deemed formed between Dialight and the purchaser of Dialight products and/or an end-user, versions of documents available at [www.dialight.com](http://www.dialight.com) as at the date of sale shall be the versions incorporated therein. In the event of any discrepancy between this document or information provided at [www.dialight.com](http://www.dialight.com), the latter shall prevail.



# Lumen Maintenance Factor

| Vigilant Bulkhead 6,500lm |       |       |       |       |       |       |       |        |
|---------------------------|-------|-------|-------|-------|-------|-------|-------|--------|
| Ambient Temperature       | Hours |       |       |       |       |       |       |        |
|                           | 0     | 15000 | 30000 | 45000 | 60000 | 75000 | 90000 | 100000 |
| 25°C                      | 100%  | 98%   | 96%   | 95%   | 93%   | 92%   | 90%   | 90%    |
| 30°C                      | 100%  | 98%   | 96%   | 95%   | 93%   | 92%   | 90%   | 90%    |
| 35°C                      | 100%  | 98%   | 96%   | 95%   | 93%   | 92%   | 90%   | 90%    |
| 40°C                      | 100%  | 98%   | 96%   | 95%   | 93%   | 92%   | 90%   | 90%    |
| 45°C                      | 100%  | 98%   | 96%   | 95%   | 93%   | 92%   | 90%   | 90%    |
| 50°C                      | 100%  | 97%   | 96%   | 95%   | 93%   | 92%   | 90%   | 89%    |
| 55°C                      | 100%  | 97%   | 96%   | 95%   | 93%   | 92%   | 90%   | 89%    |
| 60°C                      | 99%   | 97%   | 95%   | 94%   | 93%   | 91%   | 90%   | 89%    |
| 65°C                      | 99%   | 97%   | 95%   | 94%   | 92%   | 91%   | 89%   | 89%    |

Based on 9,000 hour LM80 data

| Vigilant Bulkhead 3,000lm |       |       |       |       |       |       |       |        |
|---------------------------|-------|-------|-------|-------|-------|-------|-------|--------|
| Ambient Temperature       | Hours |       |       |       |       |       |       |        |
|                           | 0     | 15000 | 30000 | 45000 | 60000 | 75000 | 90000 | 100000 |
| 25°C                      | 100%  | 98%   | 96%   | 95%   | 93%   | 92%   | 90%   | 90%    |
| 30°C                      | 100%  | 98%   | 96%   | 95%   | 93%   | 92%   | 90%   | 90%    |
| 35°C                      | 100%  | 98%   | 96%   | 95%   | 93%   | 92%   | 90%   | 90%    |
| 40°C                      | 100%  | 98%   | 96%   | 95%   | 93%   | 92%   | 90%   | 90%    |
| 45°C                      | 100%  | 98%   | 96%   | 95%   | 93%   | 92%   | 90%   | 90%    |
| 50°C                      | 100%  | 97%   | 96%   | 95%   | 93%   | 92%   | 90%   | 89%    |
| 55°C                      | 100%  | 97%   | 96%   | 95%   | 93%   | 92%   | 90%   | 89%    |
| 60°C                      | 99%   | 97%   | 95%   | 94%   | 93%   | 91%   | 90%   | 89%    |
| 65°C                      | 99%   | 97%   | 95%   | 94%   | 92%   | 91%   | 89%   | 89%    |

Based on 9,000 hour LM80 data

**DISCLAIMER.** All product information provided is, to the best of Dialight's knowledge, accurate as of the date of publication. When ordering, refer to [www.dialight.com](http://www.dialight.com) for current versions of: (a) relevant product documentation (including the relevant product data sheets); (b) Dialight terms and conditions of sale; and, (c) the relevant product warranty. To the extent that any contract is deemed formed between Dialight and the purchaser of Dialight products and/or an end-user, versions of documents available at [www.dialight.com](http://www.dialight.com) as at the date of sale shall be the versions incorporated therein. In the event of any discrepancy between this document or information provided at [www.dialight.com](http://www.dialight.com), the latter shall prevail.

# Dimming Curves

## DALI Dimming

6,500lm

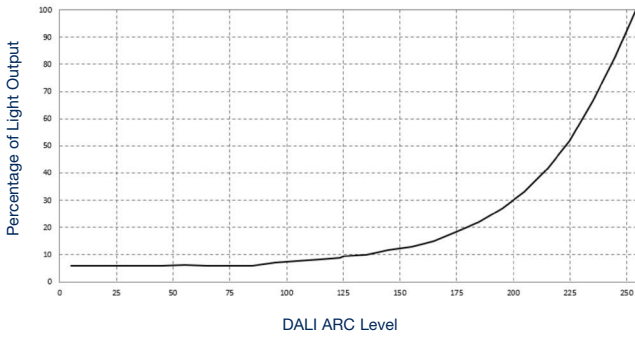

3,000lm

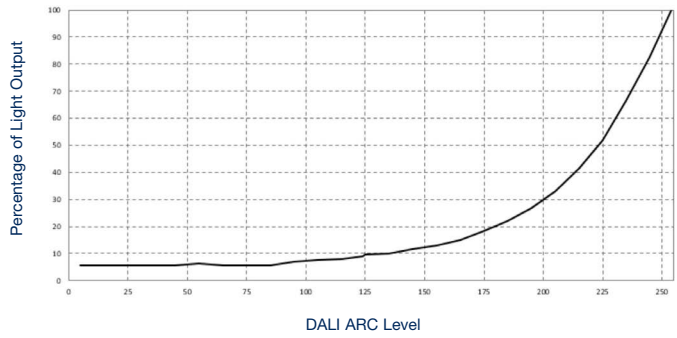

## 0-10V Dimming

6,500lm

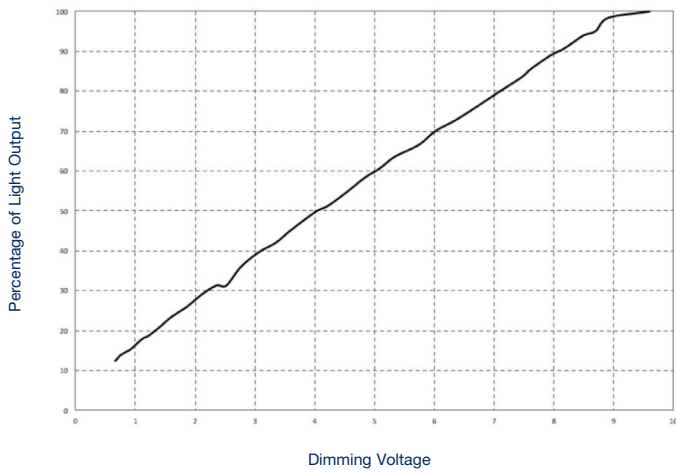

3,000lm

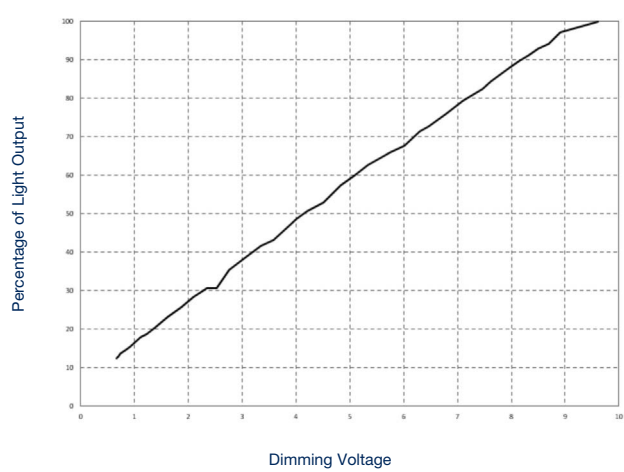

**DISCLAIMER.** All product information provided is, to the best of Dialight's knowledge, accurate as of the date of publication. When ordering, refer to [www.dialight.com](http://www.dialight.com) for current versions of: (a) relevant product documentation (including the relevant product data sheets); (b) Dialight terms and conditions of sale; and, (c) the relevant product warranty. To the extent that any contract is deemed formed between Dialight and the purchaser of Dialight products and/or an end-user, versions of documents available at [www.dialight.com](http://www.dialight.com) as at the date of sale shall be the versions incorporated therein. In the event of any discrepancy between this document or information provided at [www.dialight.com](http://www.dialight.com), the latter shall prevail.

## Australia

108 Howe Street  
Osborne Park, WA 6017  
Tel: +61 (0) 8 9244 7600  
Fax: +61 (0) 8 9244 7601  
info@dialight.com.au

## Southeast Asia

33 Ubi Avenue 3  
#07-72 Vertex (Tower A)  
Singapore 408868  
Tel: +65 6578 7157  
Fax: +65 6578 7150  
enquiry@dialight.com.sg

### WARNING / DISCLAIMERS:

**Installation & secondary retention.** The use of this product without proper installation (including secondary retention / netting) and periodic inspections, could cause severe injury or death. Dialight recommends that all installations should use secondary retention / netting (appropriate to the installation environment) as applicable. Dialight products are intended for ultimate purchase, installation and operation by knowledgeable persons trained in the functional assessment, installation, use and maintenance of such products and all customers (including but not limited to end customers) are responsible for assessing the suitability of Dialight products for any given installation requirement. It is the exclusive responsibility of the contractor, installer and/or end-user to: (a) determine the suitability of the product for its intended application; and, (b) ensure that the product is safely installed (with secondary retention / netting as appropriate) and in compliance with all applicable laws and regulations.

**Product specifications & warranties.** All product information provided is, to the best of Dialight's knowledge, accurate as of the date of publication. All values and performance data herein are design or typical values when measured under laboratory conditions. The information herein is subject to change without notice. The products / software detailed herein are subject to applicable warranties and terms and conditions of use/purchase. Unless agreed otherwise in writing by an authorized representative of Dialight, Dialight does not represent that its products are fit for any particular purpose and accepts no liability for the installation and/or unauthorised use of its products. When ordering, refer to [www.dialight.com](http://www.dialight.com) for current versions of: (a) relevant product documentation (including relevant product data sheets); (b) Dialight terms and conditions of sale; and, (c) the relevant product warranties. To the extent that any contract is deemed formed between Dialight and the purchaser of Dialight products and/or an end-user, versions of documents available at [www.dialight.com](http://www.dialight.com) as at the date of sale shall be the versions incorporated therein. In the event of any discrepancy between this document and information provided at [www.dialight.com](http://www.dialight.com), the latter shall prevail.

**Exclusion of liability.** To the extent permissible under the relevant law, Dialight disclaims all liability for personal injury and/or other damage resulting from any dislodgment or other dislocation of its products. Whilst Dialight has used its reasonable endeavours to ensure the completeness and accuracy of information herein, Dialight does not assume any liability for damages resulting from use of this information or for any third-party representations made in relation to Dialight products.