

.....Dialight



SafeSite[®] LED Stainless Steel Linear - ATEX / IECEx
for Indoor and Outdoor Industrial Applications



JANUARY 2021



Features & Benefits

- L70 rated for >150,000 hours @ 25°C ambient
- 5 year full warranty
- Significant energy savings
- Easy retrofit solution for existing fluorescent fittings due to same size and fixing centres
- Maintenance free
- Mercury free
- No UV or IR
- Resistant to shock and vibration
- Superior colour rendition index compared to HPS, LPS, MV
- Temperature compensation for longer life

Application

The Dialight SafeSite[®] LED Linear luminaire with its low profile, rugged design ensures long life and high reliability for a wide variety of Industrial area applications. Offered in 34W and 67W versions to replicate the light output of typical 2 x 18W & 2 x 36W fluorescent luminaires respectively, Dialight offers a range of mounting options for use with the SafeSite[®] Linear luminaire.

SafeSite® LED Stainless Steel Linear - ATEX / IECEx

Standard Models



Standard Models

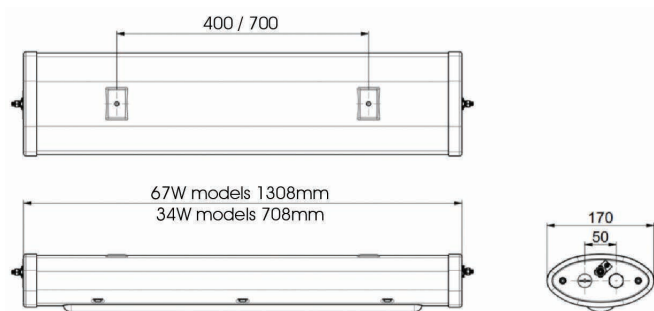

Dimensions in mm

Emergency Models

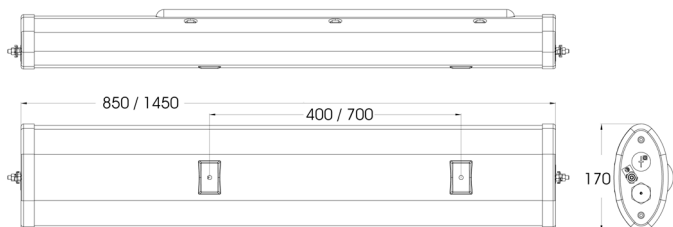

Dimensions in mm

Certifications & Ratings

- Ex e mb IIC T4 Gb (Ta = -20°C to +60°C)
- Ex tb IIIC T135°C Db (Ta = -20°C to +60°C)
- Certificate numbers: IECEx SIR 12.0093X SIRA12ATEX3217X
- ATEX Zones 1, 21
- ATEX Zones 2, 22
- CE
- EN 55015:2006
- EN 61547:2009
- EN 60598:2008
- IP66/67
- IK07 to EN 50102
- C & D shock compliant to MOD specification BR8470

Mechanical Information:

Fixture weight:

Standard Models:	1308mm - 11.3 kg (25 lb)
	708mm - 6.8 kg (15 lb)
Emergency Models:	1450mm - 14.1 kg (31 lb)
	850mm - 9.1 kg (20 lb)

Shipping weight:

Standard Models:	1308mm - 14.1 kg (31 lb)
	708mm - 9.1 kg (20 lb)
Emergency Models:	1450mm - 17.2 kg (38 lb)
	850mm - 11.3 kg (25 lb)

Box dimensions:

1308mm - 240 x 160 x 1640
708mm - 240 x 160 x 1040

Mounting:

(2) M8 fixing points

Cable Entry:

2 x M25 cable entries at both ends, through wired as standard. Consult factory for other options

Electrical specifications:

Operating Voltage:

Standard Models:	110-250 VAC, 50/60Hz
Emergency Models:	230/240 VAC, 50/60Hz

Total system power consumption:

See table

Operating Temp:

-20°C to +60°C

Noise Requirements/ EMC:

EN 61000-3-2: 2006

Transient protection:

EN61000-4-5
1 kV line-to-line
2 kV line-to-ground

Power Factor:

> 0.9

Emergency Models:

Battery:

3.6V 10Ah NiMH

Expected Battery Life*:

4 years

Battery Duration*:

>180 Minutes

Materials:

Housing and Fixings:

316 Marine grade stainless steel

Lens:

High impact resistant polycarbonate

Mounting Brackets:

316L stainless steel

Safety Shackle:

Optional factory fitted stainless steel safety shackle with 1 meter safety cord

Photometric Information:

CRI:

70

CCT:

5000K (cool white)
4000K (neutral white)

All values typical unless otherwise stated (tolerance +/- 10%)

*@ 25°C ambient

WARNING - INSTALLATION & SECONDARY RETENTION. Use of any Dialight products without proper installation (including secondary retention / netting) and periodic inspections could cause severe injury or death. Dialight recommends that all installations should use secondary retention / netting (appropriate to the installation environment) where applicable. It is the exclusive responsibility of the contractor, installer and/or end-user to: (a) determine the suitability of the product for its intended application; and, (b) ensure that the product is safely installed (with secondary retention / netting where appropriate) and in compliance with all applicable laws and regulations. To the extent permissible under applicable laws, Dialight disclaims all liability for personal injury and/or other damage resulting from any dislodgment or other dislocation of its products.

SafeSite® LED Stainless Steel Linear - ATEX / IECEx

Mounting Options and Accessories



ELX-CMB-SS

- 316 Marine Grade stainless steel ceiling mount kit



ELX-PC-SS-42

- 37Ø - 44mm range 316 Marine Grade stainless steel pole clamp



ELX-WMB-SS-30

- 30° 316 Marine Grade stainless steel wall mount kit



ELX-EYE-SS

- 316 Marine Grade stainless steel eyelet kit

ELX-PC-SS-47

- 44Ø - 50mm range 316 Marine Grade stainless steel pole clamp

ELX-WMB-SS-45

- 45° 316 Marine Grade stainless steel wall mount kit

ELX-PC-SS-54

- 50Ø - 58mm range 316 Marine Grade stainless steel pole clamp

ELX-WMB-SS-60

- 60° 316 Marine Grade stainless steel wall mount kit



ELX-BATT-KIT

- 3.6V 10Ah NiMH battery kit

ELX-PC-SS-59

- 58Ø - 68mm range 316 Marine Grade stainless steel pole clamp

ELX-WMB-SS-90

- 90° 316 Marine Grade stainless steel wall mount kit

Mounting Options and Accessory Dimensions (mm)

Pole Clamp

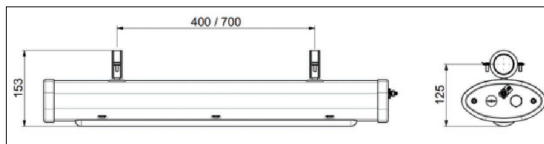

Eyelet

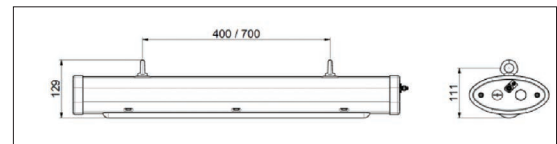

Ceiling Mount

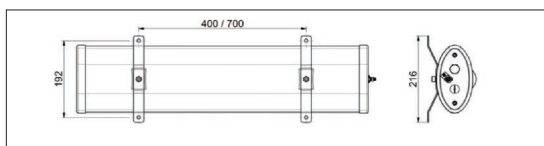

Wall Mount Bracket 30°

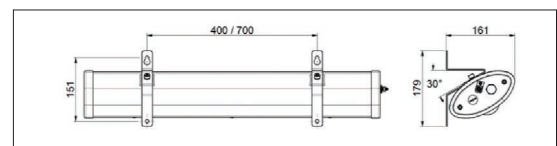

Wall Mount Bracket 45°

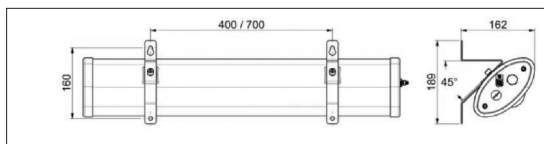

Wall Mount Bracket 60°

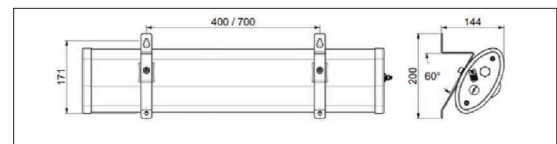

Wall Mount Bracket 90°

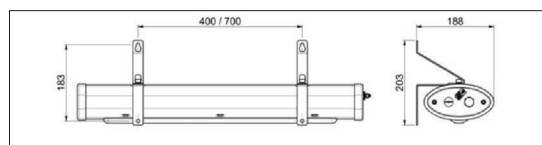

DISCLAIMER. All product information provided is, to the best of Dialight's knowledge, accurate as of the date of publication. When ordering, refer to www.dialight.com for current versions of: (a) relevant product documentation (including the relevant product data sheets); (b) Dialight terms and conditions of sale; and, (c) the relevant product warranty. To the extent that any contract is deemed formed between Dialight and the purchaser of Dialight products and/or an end-user, versions of documents available at www.dialight.com as at the date of sale shall be the versions incorporated therein. In the event of any discrepancy between this document or information provided at www.dialight.com, the latter shall prevail.

SafeSite® LED Stainless Steel Linear - ATEX / IECEx

Ordering Information

Current Part Number	Historic Part Number	Fixture Lumens	Wattage	lm/W	Voltage	Colour Temperature (CCT)	Lens	Beam Distribution
Standard Models								
ELA-1C6R-SSCB4	ELA-1C3R-SSCB	5,100	67	76	110-250 VAC	5000K (cool white)	Polycarbonate	Medium
ELA-1N6R-SSCB4	ELA-1N3R-SSCB	4,800	67	72	110-250 VAC	4000K (neutral white)	Polycarbonate	Medium
ELA-1C6M-SSCB4	ELA-1C3M-SSCB	2,600	34	76	110-250 VAC	5000K (cool white)	Polycarbonate	Medium
ELA-1N6M-SSCB4	ELA-1N3M-SSCB	2,450	34	72	110-250 VAC	4000K (neutral white)	Polycarbonate	Medium
Emergency Models								
ELEA-2C7R-SSCB4	ELEA-2C4R-SSCB	5,100	70	73	230/240 VAC	5000K (cool white)	Polycarbonate	Medium
ELEA-2N7R-SSCB4	ELEA-2N4R-SSCB	4,800	70	68	230/240 VAC	4000K (neutral white)	Polycarbonate	Medium
ELEA-2C7M-SSCB4	ELEA-2C4M-SSCB	2,600	35	74	230/240 VAC	5000K (cool white)	Polycarbonate	Medium
ELEA-2N7M-SSCB4	ELEA-2N4M-SSCB	2,450	35	70	230/240 VAC	4000K (neutral white)	Polycarbonate	Medium

Lm/W are under constant review and improvement, please consult technical department for latest achievable values
 For factory fitted safety shackle option, add 1 as a suffix to the part code. E.g.: ELA-1C3R-SSCB-1

Light Distribution Pattern

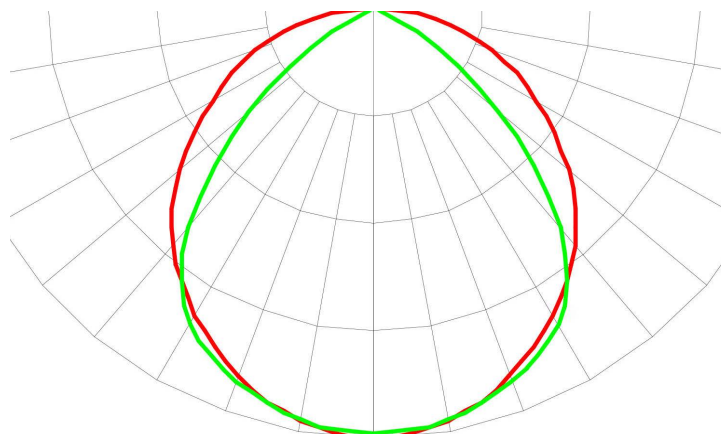

DISCLAIMER. All product information provided is, to the best of Dialight's knowledge, accurate as of the date of publication. When ordering, refer to www.dialight.com for current versions of: (a) relevant product documentation (including the relevant product data sheets); (b) Dialight terms and conditions of sale; and, (c) the relevant product warranty. To the extent that any contract is deemed formed between Dialight and the purchaser of Dialight products and/or an end-user, versions of documents available at www.dialight.com as at the date of sale shall be the versions incorporated therein. In the event of any discrepancy between this document or information provided at www.dialight.com, the latter shall prevail.

EMEA Technical Centre

Ejby Industrivej 91 B
200 Glostrup
Tel: +45 8877 4545 (Denmark)
Tel: +44 1638 666541 (UK)
Tel: +49 89 12089 5713 (Germany)
Tel: +33 3 23 22 62 58 (France)
sales-europe@dialight.com

Middle East

Level 42
Emirates Towers (Office Tower)
Sheikh Zayed Road
Dubai, United Arab Emirates
Fax: +971 (0) 4319 7686
Tel: +971 (0) 4319 7686

Australia

108 Howe Street
Osborne Park, WA 6017
Tel: +61 (0) 8 9244 7600
Fax: +61 (0) 8 9244 7601
info@dialight.com.au

Southeast Asia

33 Ubi Avenue 3
#07-72 Vertex (Tower A)
Singapore 408868
Tel: +65 6578 7157
Fax: +65 6578 7150
enquiry@dialight.com.sg

WARNING / DISCLAIMERS:

Installation & secondary retention. The use of this product without proper installation (including secondary retention / netting) and periodic inspections, could cause severe injury or death. Dialight recommends that all installations should use secondary retention / netting (appropriate to the installation environment) as applicable. Dialight products are intended for ultimate purchase, installation and operation by knowledgeable persons trained in the functional assessment, installation, use and maintenance of such products and all customers (including but not limited to end customers) are responsible for assessing the suitability of Dialight products for any given installation requirement. It is the exclusive responsibility of the contractor, installer and/or end-user to: (a) determine the suitability of the product for its intended application; and, (b) ensure that the product is safely installed (with secondary retention / netting as appropriate) and in compliance with all applicable laws and regulations.

Product specifications & warranties. All product information provided is, to the best of Dialight's knowledge, accurate as of the date of publication. All values and performance data herein are design or typical values when measured under laboratory conditions. The information herein is subject to change without notice. The products / software detailed herein are subject to applicable warranties and terms and conditions of use/purchase. Unless agreed otherwise in writing by an authorized representative of Dialight, Dialight does not represent that its products are fit for any particular purpose and accepts no liability for the installation and/or unauthorised use of its products. When ordering, refer to www.dialight.com for current versions of: (a) relevant product documentation (including relevant product data sheets); (b) Dialight terms and conditions of sale; and, (c) the relevant product warranties. To the extent that any contract is deemed formed between Dialight and the purchaser of Dialight products and/or an end-user, versions of documents available at www.dialight.com as at the date of sale shall be the versions incorporated therein. In the event of any discrepancy between this document and information provided at www.dialight.com, the latter shall prevail.

Exclusion of liability. To the extent permissible under the relevant law, Dialight disclaims all liability for personal injury and/or other damage resulting from any dislodgment or other dislocation of its products. Whilst Dialight has used its reasonable endeavours to ensure the completeness and accuracy of information herein, Dialight does not assume any liability for damages resulting from use of this information or for any third-party representations made in relation to Dialight products.