



# Dialight® LED High Output High Bay - Low Profile

## Technical Specification Sheet - APAC

## Vigilant® LED High Output High Bay - Low Profile Standard Models



### Certifications & Ratings\*

- 10 year warranty
- CE / RCM / ENEC
- IP66/67
- IK10 (polycarbonate) / IK06 (glass)
- L70 > 150,000 hours
- Factory installed secondary retention bracket, optional safety cable accessory available

\*Values based on preliminary data awaiting validation or certification.

### Mechanical Information:

<b>Fixture weight:</b>	21.8 kg (48 lbs)
<b>Shipping weight:</b>	28.1 kg (62 lbs)
<b>Mounting:</b>	(1) Loop
<b>Wiring entries:</b>	(2) M25

### Materials:

<b>Housing:</b>	A360 Die-cast aluminium
<b>Finish:</b>	Superior dual coat finish - Sealed polyester topcoat - Chemical-resistant epoxy primer
<b>Lens options:</b>	Tempered glass, Acrylic or Polycarbonate
<b>Hardware:</b>	316 Stainless Steel

### Electrical Specifications:

<b>Operating voltage:</b>	120-277 VAC, 50/60Hz
<b>Total system power consumption:</b>	See table
<b>Operating temperature:</b>	-40°C to +65°C
<b>Harmonics:</b>	IEC 61000-3-2 Class C
<b>Surge protection:</b>	Tested to IEC 61000-4-5 6kV/3kA, 1.2/50, 8/20us Combination wave Line-line and line-ground
<b>THD:</b>	< 20%
<b>Power factor:</b>	> 0.9

### Photometric Information:

<b>CRI:</b>	80
<b>CCT:</b>	5000K (cool white) 4000K (neutral white)

All values typical unless otherwise stated (tolerance +/- 10%)

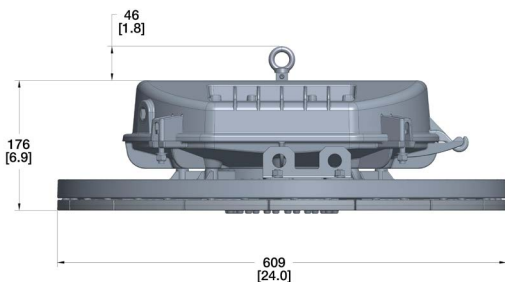
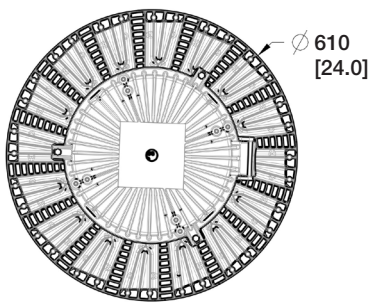

Dimensions in mm [inches]

**WARNING - INSTALLATION & SECONDARY RETENTION.** Use of any Dialight products without proper installation (including secondary retention / netting) and periodic inspections could cause severe injury or death. Dialight recommends that all installations should use secondary retention / netting (appropriate to the installation environment) where applicable. It is the exclusive responsibility of the contractor, installer and/or end-user to: (a) determine the suitability of the product for its intended application; and, (b) ensure that the product is safely installed (with secondary retention / netting where appropriate) and in compliance with all applicable laws and regulations. To the extent permissible under applicable laws, Dialight disclaims all liability for personal injury and/or other damage resulting from any dislodgment or other dislocation of its products.

# Ordering Information

## Vigilant® LED High Output High Bay - Low Profile - Standard Models



Part Number	Fixture Lumen	Watt	lm/W	Voltage	CCT	CRI	Lens	Beam Distribution	Dimming
<b>CE Standard Models - 120-277 VAC Models</b>									
H7E-7NN2-KDHN-NGN	46,000	300	153	120-277 VAC	4000K (neutral white)	80	Glass	Narrow	0-10V
H7E-7MN2-KDHN-NGN	46,000	300	153	120-277 VAC	4000K (neutral white)	80	Glass	Medium	0-10V
<b>H7E-7NN2-NDHN-NGN</b>	61,200	418	146	120-277 VAC	4000K (neutral white)	80	Glass	Narrow	0-10V
H7E-7MN2-NDHN-NGN	61,200	418	146	120-277 VAC	4000K (neutral white)	80	Glass	Medium	0-10V
H7E-7NN2-RDHN-NGN	70,500	485	145	120-277 VAC	4000K (neutral white)	80	Glass	Narrow	0-10V
H7E-7NC2-KDHN-NGN	46,000	300	153	120-277 VAC	5000K (cool white)	80	Glass	Narrow	0-10V
H7E-7MC2-KDHN-NGN	46,000	300	153	120-277 VAC	5000K (cool white)	80	Glass	Medium	0-10V
H7E-7NC2-NDHN-NGN	61,200	418	146	120-277 VAC	5000K (cool white)	80	Glass	Narrow	0-10V
H7E-7MC2-NDHN-NGN	61,200	418	146	120-277 VAC	5000K (cool white)	80	Glass	Medium	0-10V
H7E-7NC2-RDHN-NGN	70,500	485	145	120-277 VAC	5000K (cool white)	80	Glass	Narrow	0-10V

All values typical unless otherwise stated (tolerance +/- 10%).

Part numbers listed in **bold** are typically available in stock.

Cool white color temperature (5000K) is available for products in the above table. Replace the sixth character **N** with **C**. Ex. H7E-7MN2-RDHN-NGN becomes H7E-7MC2-RDHN-NGN.

**WARNING - INSTALLATION & SECONDARY RETENTION.** Use of any Dialight products without proper installation (including secondary retention / netting) and periodic inspections could cause severe injury or death. Dialight recommends that all installations should use secondary retention / netting (appropriate to the installation environment) where applicable. It is the exclusive responsibility of the contractor, installer and/or end-user to: (a) determine the suitability of the product for its intended application; and, (b) ensure that the product is safely installed (with secondary retention / netting where appropriate) and in compliance with all applicable laws and regulations. To the extent permissible under applicable laws, Dialight disclaims all liability for personal injury and/or other damage resulting from any dislodgment or other dislocation of its products.

# Beam Distribution

Narrow

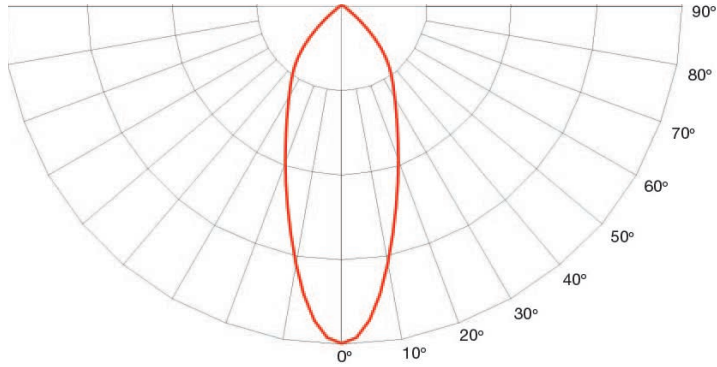

Medium

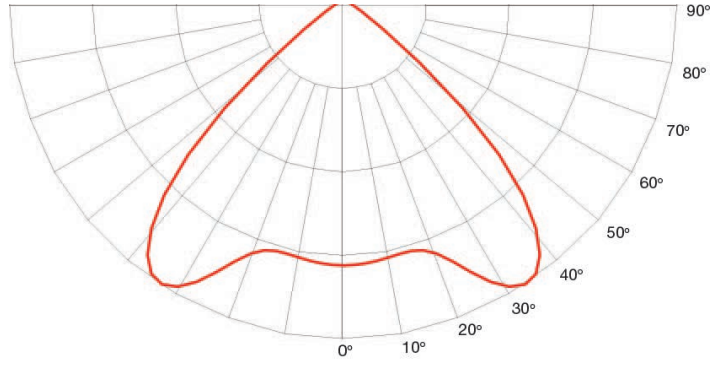

# Thermal Roll-Off

Thermal Rolloff (277V)

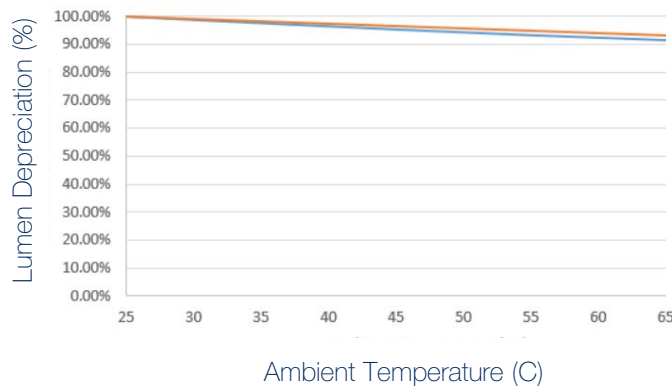

Thermal Rolloff (480V)

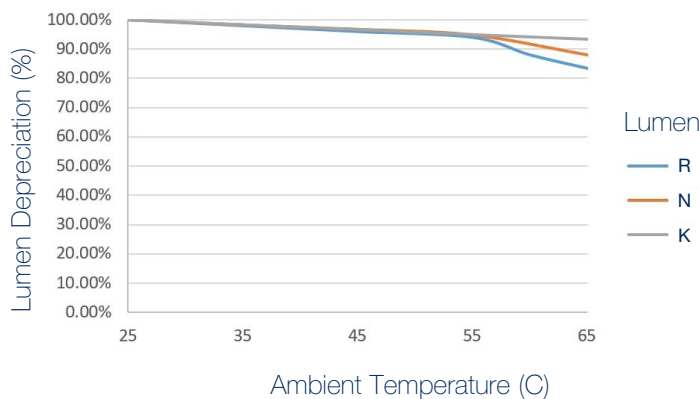

**WARNING - INSTALLATION & SECONDARY RETENTION.** Use of any Dialight products without proper installation (including secondary retention / netting) and periodic inspections could cause severe injury or death. Dialight recommends that all installations should use secondary retention / netting (appropriate to the installation environment) where applicable. It is the exclusive responsibility of the contractor, installer and/or end-user to: (a) determine the suitability of the product for its intended application; and, (b) ensure that the product is safely installed (with secondary retention / netting where appropriate) and in compliance with all applicable laws and regulations. To the extent permissible under applicable laws, Dialight disclaims all liability for personal injury and/or other damage resulting from any dislodgment or other dislocation of its products.

## In Rush Current / Circuit Breakers

In rush current @ input voltage				Time duration of in rush current @ input voltage			
120 VAC	277 VAC	347 VAC	480 VAC	120 VAC	277 VAC	347 VAC	480 VAC
15A	36A	8A	11A	1.5 ms	1.5 ms	.88 ms	.88 ms

Maximum number of lights per breaker						
	120 VAC			277 VAC		
Model	C10	B16	C16	C10	B16	C16
K	3	4	4	5	8	8
N	2	3	3	4	6	6
R	2	2	2	3	5	5
	347 VAC			480 VAC		
Model	C10	B16	C16	C10	B16	C16
K	7	12	12	9	15	15
N	5	8	8	7	11	11
R	5	7	7	6	9	9

## Mounting Accessories



### H6XCAB72

- 72" stainless steel safety rope

### H6XCAB60

- 60" stainless steel safety rope



### H6XDIFFUSER

- Diffuser
- Patent pending

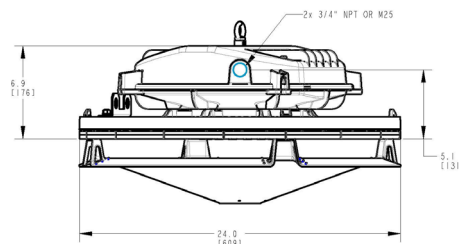

Dimensions in inches [mm]

**WARNING - INSTALLATION & SECONDARY RETENTION.** Use of any Dialight products without proper installation (including secondary retention / netting) and periodic inspections could cause severe injury or death. Dialight recommends that all installations should use secondary retention / netting (appropriate to the installation environment) where applicable. It is the exclusive responsibility of the contractor, installer and/or end-user to: (a) determine the suitability of the product for its intended application; and, (b) ensure that the product is safely installed (with secondary retention / netting where appropriate) and in compliance with all applicable laws and regulations. To the extent permissible under applicable laws, Dialight disclaims all liability for personal injury and/or other damage resulting from any dislodgment or other dislocation of its products.

## Australia

108 Howe Street  
Osborne Park, WA 6017  
Tel: +61 (0) 8 9244 7600  
Fax: +61 (0) 8 9244 7601  
info@dialight.com.au

## Southeast Asia

33 Ubi Avenue 3  
#07-72 Vertex (Tower A)  
Singapore 408868  
Tel: +65 6578 7157  
Fax: +65 6578 7150  
enquiry@dialight.com.sg

### WARNING / DISCLAIMERS:

**Installation & secondary retention.** The use of this product without proper installation (including secondary retention / netting) and periodic inspections, could cause severe injury or death. Dialight recommends that all installations should use secondary retention / netting (appropriate to the installation environment) as applicable. Dialight products are intended for ultimate purchase, installation and operation by knowledgeable persons trained in the functional assessment, installation, use and maintenance of such products and all customers (including but not limited to end customers) are responsible for assessing the suitability of Dialight products for any given installation requirement. It is the exclusive responsibility of the contractor, installer and/or end-user to: (a) determine the suitability of the product for its intended application; and, (b) ensure that the product is safely installed (with secondary retention / netting as appropriate) and in compliance with all applicable laws and regulations.

**Product specifications & warranties.** All product information provided is, to the best of Dialight's knowledge, accurate as of the date of publication. All values and performance data herein are design or typical values when measured under laboratory conditions. The information herein is subject to change without notice. The products / software detailed herein are subject to applicable warranties and terms and conditions of use/purchase. Unless agreed otherwise in writing by an authorized representative of Dialight, Dialight does not represent that its products are fit for any particular purpose and accepts no liability for the installation and/or unauthorised use of its products. When ordering, refer to [www.dialight.com](http://www.dialight.com) for current versions of: (a) relevant product documentation (including relevant product data sheets); (b) Dialight terms and conditions of sale; and, (c) the relevant product warranties. To the extent that any contract is deemed formed between Dialight and the purchaser of Dialight products and/or an end-user, versions of documents available at [www.dialight.com](http://www.dialight.com) as at the date of sale shall be the versions incorporated therein. In the event of any discrepancy between this document and information provided at [www.dialight.com](http://www.dialight.com), the latter shall prevail.

**Exclusion of liability.** To the extent permissible under the relevant law, Dialight disclaims all liability for personal injury and/or other damage resulting from any dislodgment or other dislocation of its products. Whilst Dialight has used its reasonable endeavours to ensure the completeness and accuracy of information herein, Dialight does not assume any liability for damages resulting from use of this information or for any third-party representations made in relation to Dialight products.