

# .....Dialight



**SafeSite<sup>®</sup> LED Stainless Steel Linear - ATEX / IECEx**  
for Indoor and Outdoor Industrial Applications





## Features & Benefits

- L70 rated for >150,000 hours @ 25°C ambient
- 10 year warranty
- Significant energy savings
- Easy retrofit solution for existing fluorescent fittings due to same size and fixing centres
- Maintenance free
- Mercury free
- No UV or IR
- Resistant to shock and vibration
- Superior colour rendition index compared to HPS, LPS, MV
- Temperature compensation for longer life

## Application

The Dialight SafeSite<sup>®</sup> LED Linear luminaire with its low profile, rugged design ensures long life and high reliability for a wide variety of Industrial area applications. Offered in 27W and 54W versions to replicate the light output of typical 2 x 18W & 2 x 36W fluorescent luminaires respectively, Dialight offers a range of mounting options for use with the SafeSite<sup>®</sup> Linear luminaire.

# SafeSite® LED Stainless Steel Linear - ATEX / IECEx

## Standard Models - Zone 2, 21 & 22



Standard Models

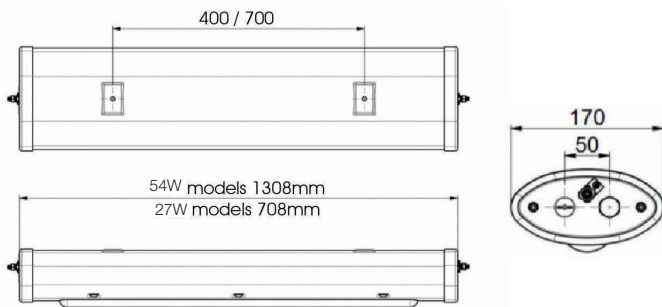

Dimensions in mm

### Certifications & Ratings

- Ex ec mc IIC T4 Gc
- Ex tb IIIc T135°C Db
-  II 3 G  
II 2 D
- ATEX/IECEx Zones 2, 21 & 22
  - IECEx SIR 19.0002X
  - Sira 19ATEX9002X
  - Sira 19ATEX3003X
  - EN 60079-0:2018
  - EN 60079-7:2015+A1:2018
  - EN 60079-18:2015+A1:2018
  - EN 60079-31:2014
- CE
- EN 55015:2013
- EN 61547:2009
- EN 60598-1:2015
- IP66/67
- IK07 to EN 62262

### Mechanical Information:

<b>Fixture weight:</b>	1308mm - 11.3 kg (25 lb) 708mm - 6.8 kg (15 lb)
<b>Shipping weight:</b>	1308mm - 14.1 kg (31 lb) 708mm - 9.1 kg (20 lb)
<b>Box dimensions:</b>	1308mm - 240 x 160 x 1640 708mm - 240 x 160 x 1040
<b>Mounting:</b>	(2) M8 fixing points
<b>Cable Entry:</b>	2 x M20 entries at each end

### Electrical specifications:

<b>Operating Voltage:</b>	100-277 VAC, 50/60Hz
<b>Total system power consumption:</b>	See table
<b>Operating Temp:</b>	-20°C to +60°C
<b>Noise Requirements/ EMC:</b>	EN 55015:2013 EN 61547:2009 EN 61000-3-2:2014-05
<b>Transient protection:</b>	EN 61000-4-5:2014 6 kV line-to-line 6 kV line-to-ground
<b>Power Factor:</b>	> 0.9

### Materials:

<b>Housing and Fixings:</b>	316 Marine grade stainless steel
<b>Lens:</b>	High impact resistant polycarbonate
<b>Mounting Brackets:</b>	316 stainless steel
<b>Safety Shackle:</b>	Optional factory fitted stainless steel safety shackle with 1 meter safety cord

### Photometric Information:

<b>CRI:</b>	80
<b>CCT:</b>	5000K (cool white) 4000K (neutral white) 2700K (warm white)

All values typical unless otherwise stated (tolerance +/- 10%)

**WARNING - INSTALLATION & SECONDARY RETENTION.** Use of any Dialight products without proper installation (including secondary retention / netting) and periodic inspections could cause severe injury or death. Dialight recommends that all installations should use secondary retention / netting (appropriate to the installation environment) where applicable. It is the exclusive responsibility of the contractor, installer and/or end-user to: (a) determine the suitability of the product for its intended application; and, (b) ensure that the product is safely installed (with secondary retention / netting where appropriate) and in compliance with all applicable laws and regulations. To the extent permissible under applicable laws, Dialight disclaims all liability for personal injury and/or other damage resulting from any dislodgment or other dislocation of its products.

# SafeSite® LED Stainless Steel Linear - ATEX / IECEx

## Mounting Options and Accessories



### ELX-CMB-SS

- 316 Marine Grade stainless steel ceiling mount kit



### ELX-PC-SS-42

- 40Ø - 45mm range 316 Marine Grade stainless steel pole clamp



### ELX-WMB-SS-30

- 30° 316 Marine Grade stainless steel wall mount kit



### ELX-EYE-SS

- 316 Marine Grade stainless steel eyelet kit

### ELX-PC-SS-47

- 47Ø - 51mm range 316 Marine Grade stainless steel pole clamp

### ELX-WMB-SS-45

- 45° 316 Marine Grade stainless steel wall mount kit

### ELX-PC-SS-54

- 54Ø - 57mm range 316 Marine Grade stainless steel pole clamp

### ELX-WMB-SS-60

- 60° 316 Marine Grade stainless steel wall mount kit

### ELX-PC-SS-59

- 59Ø - 62mm range 316 Marine Grade stainless steel pole clamp

### ELX-WMB-SS-90

- 90° 316 Marine Grade stainless steel wall mount kit

## Mounting Options and Accessory Dimensions (mm)

### Pole Clamp

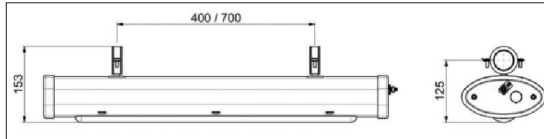

### Eyelet

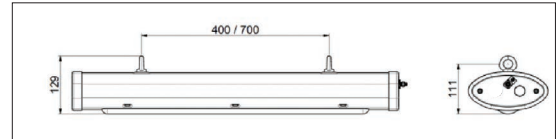

### Ceiling Mount

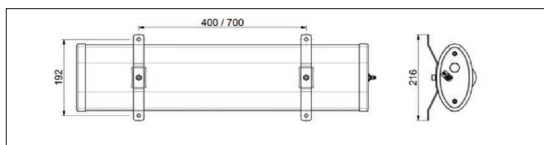

### Wall Mount Bracket 30°

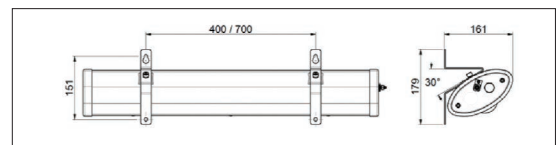

### Wall Mount Bracket 45°

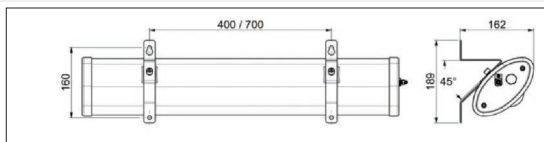

### Wall Mount Bracket 60°

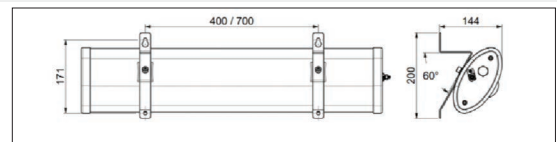

### Wall Mount Bracket 90°

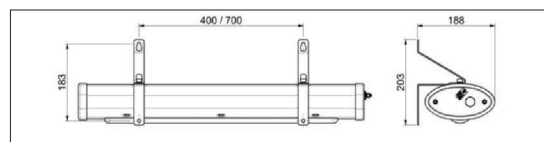

**DISCLAIMER.** All product information provided is, to the best of Dialight's knowledge, accurate as of the date of publication. When ordering, refer to [www.dialight.com](http://www.dialight.com) for current versions of: (a) relevant product documentation (including the relevant product data sheets); (b) Dialight terms and conditions of sale; and, (c) the relevant product warranty. To the extent that any contract is deemed formed between Dialight and the purchaser of Dialight products and/or an end-user, versions of documents available at [www.dialight.com](http://www.dialight.com) as at the date of sale shall be the versions incorporated therein. In the event of any discrepancy between this document or information provided at [www.dialight.com](http://www.dialight.com), the latter shall prevail.

# SafeSite® LED Stainless Steel Linear - ATEX / IECEx

## Ordering Information

Part Number	Fixture Lumens	Wattage	lm/W	IP Rating	Voltage	Color Temperature (CCT)	Lens	Beam Distribution
Standard Models								
SBB5MC26NCN1NN	5,400	54	100	IP66/67	100-277 VAC	5000K (cool white)	Polycarbonate	Medium
SAB5MC23NCN1NN	2,700	27	100	IP66/67	100-277 VAC	5000K (cool white)	Polycarbonate	Medium

Beam Distribution

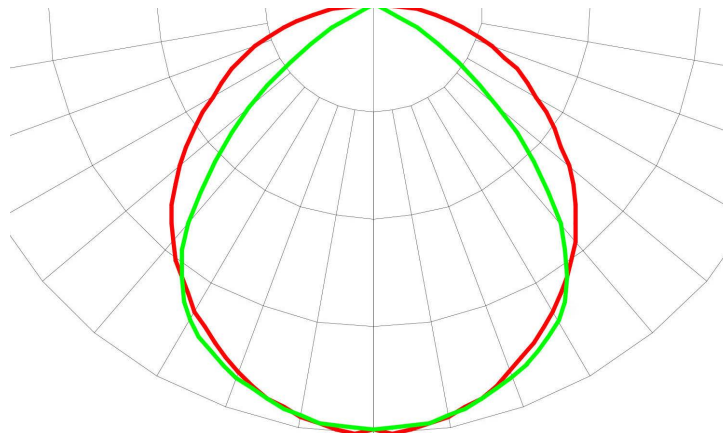

## North American HQ

1501 Route 34 South  
Farmingdale, NJ 07727  
Tel: 732-919-3119  
Fax: 732-751-5778  
info@dialight.com

## Dialight Europe Ltd

Leaf C, Level 36, Tower 42  
25 Old Broad Street  
London, EC2N 1HQ, United Kingdom  
Tel: +44 (0) 203 058 3540  
Customer Service: +44 (0) 163 866 6541  
sales-emea@dialight.com

## Middle East

Level 23 – Boulevard Plaza Tower 2  
Emaar Boulevard, Dubai, U.A.E.  
P.O. Box 124342  
Tel: +971 (4) 409-6962  
Fax: +971 (4) 409-6850

## Australia

108 Howe Street  
Osborne Park, WA 6017  
Tel: +61 (0) 8 9244 7600  
Fax: +61 (0) 8 9244 7601  
info@dialight.com.au

## Southeast Asia

33 Ubi Avenue 3  
#07-72 Vertex (Tower A)  
Singapore 408868  
Tel: +65 6578 7157  
Fax: +65 6578 7150  
enquiry@dialight.com.sg

## Brazil

Alameda Mercurio,  
225 – American Park Empresarial NR  
Indaiatuba – SP – 13347– 662  
Tel: +55 (19) 3113-4300  
Fax: +55 (19) 3113-4300  
brasil@dialight.com

### WARNING / DISCLAIMERS:

**Installation & secondary retention.** The use of this product without proper installation (including secondary retention / netting) and periodic inspections, could cause severe injury or death. Dialight recommends that all installations should use secondary retention / netting (appropriate to the installation environment) as applicable. Dialight products are intended for ultimate purchase, installation and operation by knowledgeable persons trained in the functional assessment, installation, use and maintenance of such products and all customers (including but not limited to end customers) are responsible for assessing the suitability of Dialight products for any given installation requirement. It is the exclusive responsibility of the contractor, installer and/or end-user to: (a) determine the suitability of the product for its intended application; and, (b) ensure that the product is safely installed (with secondary retention / netting as appropriate) and in compliance with all applicable laws and regulations.

**Product specifications & warranties.** All product information provided is, to the best of Dialight's knowledge, accurate as of the date of publication. All values and performance data herein are design or typical values when measured under laboratory conditions. The information herein is subject to change without notice. The products / software detailed herein are subject to applicable warranties and terms and conditions of use/purchase. Unless agreed otherwise in writing by an authorized representative of Dialight, Dialight does not represent that its products are fit for any particular purpose and accepts no liability for the installation and/or unauthorised use of its products. When ordering, refer to [www.dialight.com](http://www.dialight.com) for current versions of: (a) relevant product documentation (including relevant product data sheets); (b) Dialight terms and conditions of sale; and, (c) the relevant product warranties. To the extent that any contract is deemed formed between Dialight and the purchaser of Dialight products and/or an end-user, versions of documents available at [www.dialight.com](http://www.dialight.com) as at the date of sale shall be the versions incorporated therein. In the event of any discrepancy between this document and information provided at [www.dialight.com](http://www.dialight.com), the latter shall prevail.

**Exclusion of liability.** To the extent permissible under the relevant law, Dialight disclaims all liability for personal injury and/or other damage resulting from any dislodgment or other dislocation of its products. Whilst Dialight has used its reasonable endeavours to ensure the completeness and accuracy of information herein, Dialight does not assume any liability for damages resulting from use of this information or for any third-party representations made in relation to Dialight products.