

Installation / Operating Instructions

These instructions contain safety information, read and follow them carefully.

Dialight will not accept any responsibility for injury, damage or loss which may occur due to incorrect installation, operation or maintenance.

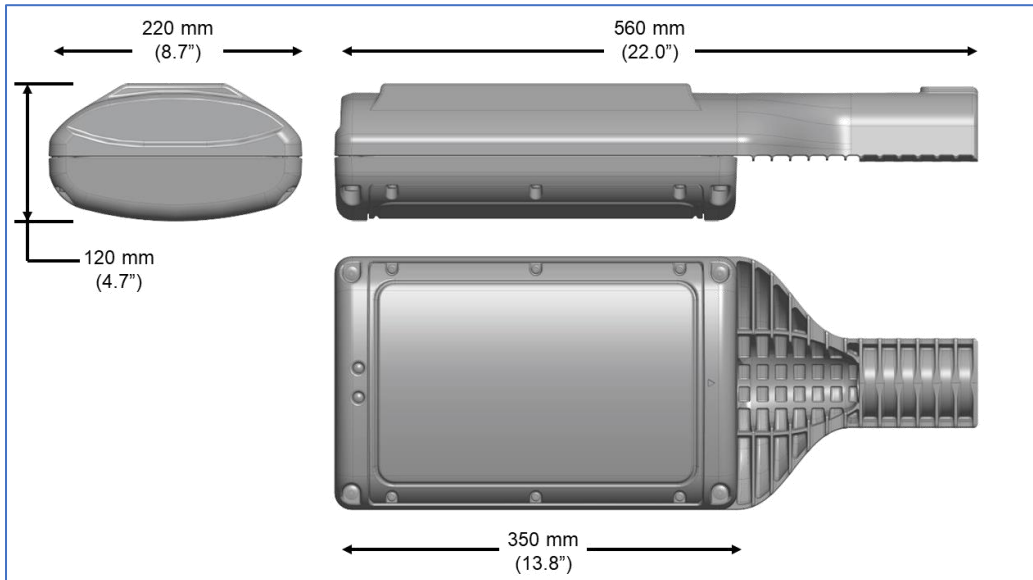

Installation / Operating Instructions
 Installationshinweise / Gebrauchsanleitung
 Instrucciones de instalación / funcionamiento
 Manuel d'installation / d'utilisation
 Instruções de instalação / operação



Note: Save these instructions for future use

WARNING: INSTALLATION & SECONDARY RETENTION. The use of this product without proper installation and inspections, including secondary safety retention/securing/netting, could cause severe injury or death. Dialight recommends that all installations should use secondary retention and/or safety netting (appropriate to the installation environment) where applicable. It is the exclusive responsibility of the contractor, installer and/or end customer to: (a) determine the suitability of the product for its intended application; and, (b) ensure that the product is installed safely (with secondary retention and/or safety netting where appropriate) and in compliance with all applicable laws and regulations. To the extent permissible under the relevant law, Dialight disclaims all responsibility for personal injury and/or other damage resulting from any dislodgement or other dislocation of this product.

ADVERTENCIA: INSTALACIÓN Y SISTEMA SECUNDARIO DE SUJECIÓN. Usar este producto sin haberlo instalado e inspeccionado correctamente, lo que incluye usar sistemas secundarios de retención/sujeción/redes, podría ocasionar lesiones graves o la muerte. Dialight recomienda que en todas las instalaciones se utilice un sistema secundario de retención o una red de seguridad (apropiados para el lugar de la instalación), según corresponda. Será responsabilidad exclusiva del contratista, el instalador o el cliente final encargarse de lo siguiente: a) determinar si el producto es apto para el uso previsto; y b) asegurarse de que el producto se instale de manera segura (usando un sistema secundario de retención o una red de seguridad, si corresponde) y de conformidad con todas las leyes y disposiciones aplicables. En la máxima medida autorizada por la legislación pertinente, Dialight no será responsable por ninguna lesión personal u otros daños que se produzcan a raíz de cualquier caída o desplazamiento de este producto.

AVISO: INSTALAÇÃO E RETENÇÃO SECUNDÁRIA. O uso deste produto sem a instalação e inspeções adequadas, incluindo retenção/fixação secundárias e/ou redes de segurança, pode provocar ferimentos sérios ou morte. A Dialight recomenda que todas as instalações utilizem retenção secundária e/ou redes de segurança (apropriadas ao ambiente da instalação) sempre que aplicável. É responsabilidade exclusiva da empreiteira, instaladora e/ou do cliente final: (a) determinar a adequabilidade deste produto para a aplicação pretendida; e, (b) assegurar que o produto seja instalado de maneira segura (com retenção secundária e/ou rede de segurança sempre que apropriado) e em conformidade com todas as leis e regulamentações aplicáveis. Dentro dos limites permitidos pela legislação pertinente, a Dialight se exime de toda responsabilidade por ferimentos pessoais e/ou outros danos resultantes do desalojamento ou de outro deslocamento deste produto.

AVERTISSEMENT : INSTALLATION ET FIXATION SECONDAIRE. L'utilisation de ce produit sans une installation et des inspections en bonne et due forme, notamment la sécurisation/ la fixation de sécurité secondaires/ l'installation d'une grille en acier tissée de sécurité, peut entraîner des blessures graves voire la mort. Dialight recommande que toutes les installations soient pourvues d'une fixation secondaire ou d'une grille en acier tissée de sécurité (adaptées à l'environnement de l'installation) dans la mesure du possible. Il va de la responsabilité exclusive de l'entrepreneur, de l'installateur ou du client final de : (a) déterminer si le produit est adapté à son usage prévu et (b) assurer que le produit est installé de manière sûre (avec une fixation secondaire et/ou une grille en acier tissée de sécurité le cas échéant) et en conformité avec la loi et les normes en vigueur. Dans la mesure permise par la loi en vigueur, Dialight n'assumera aucune responsabilité en cas de blessure sur la personne ou autre dommage résultant du déboîtement ou de toute autre dislocation de ce produit.

WARNUNG: INSTALLATION UND ZWEITE ABHÄNGUNG. Die Verwendung dieses Produkts ohne ordnungsgemäße Installation und Inspektionen, einschließlich einer zweiten Abhängung/eines Sicherheitsnetzes, könnte zu schweren Verletzungen oder Tod führen. Dialight empfiehlt bei allen Installationen die Verwendung einer zweiten Abhängung und/oder eines Sicherheitsnetzes (entsprechend der Installationsumgebung). Es ist die ausschließliche Verantwortlichkeit des Vertragsnehmers, Monteurs und/oder Endkunden: (a) die Eignung des Produkts für seinen vorgesehenen Nutzungszweck zu bestimmen und (b) sicherzustellen, dass das Produkt sicher (mit ggf. zweiter Abhängung und/oder einem Sicherheitsnetz) und gemäß allen geltenden Gesetzen und Vorschriften montiert wird. Soweit gemäß dem geltenden Gesetz erlaubt, schließt Dialight jegliche Haftung für Körperverletzung und/oder andere Schäden aufgrund einer Entfernung oder anderen Positionsänderung dieses Produkts aus.

WARNING:

To avoid the risk of fire, explosion, or electric shock, this product should be installed, inspected, and maintained by a qualified electrician in accordance with all applicable electrical rules and regulation.

Safety Instruction:

To avoid electric shock:

- Be certain electrical power is OFF before and during installation and maintenance.
- Luminaire must be connected to a wiring system with an equipment-grounding conductor.
- Make sure the supply voltage is the same as the rated luminaire voltage.
- The technical data indicated on the LED luminaires are to be observed.
- Changes of the design and modifications to the LED luminaire are not permitted.
- Observe the national/regional electrical safety rules and regulations during installation.

Technical Data:

Category of Application:

B*A*****
 Ex eb mb IIC T4 Gb
 Ex tb IIIC T130°C Db
 CSANe 21ATEX3245X
 IECEx 21.0047X
 CSAE 21UKEX3508X

B*B*****
 Ex ec IIC T4 Gc
 Ex tb IIIC T130°C Db
 Ex tc IIIC T130°C Dc
 CSANe 21ATEX3246X
 CSANe 21ATEX9272X
 IECEx 21.0047X
 CSAE 21UKEX3509X
 CSAE 21UKEX9735X

Operating Temperature Range:

-40°C ≤ T _a ≤ +65°C (-40°F ≤ T _a ≤ +149°F)	B*****N
-20°C ≤ T _a ≤ +55°C (-4°F ≤ T _a ≤ +131°F)	B*****E/F/G

Operating Voltage:

100–277 VAC 50/60Hz / 120–250 VDC	B****2*****N
230/240 VAC	B****G*****E/F/G
110/120 VAC	B****1*****E/F/G

Power: See chart below

Housing Material:

Copper-free Cast Aluminum

Weight:

7.9kg (17.4lb)	Standard Design
8.8kg (19.4lb)	Battery Backup

POWER CHART: All figures are MAXIMUMS		Standard Design			Battery Backup		
		100Vac	230Vac	277Vac	100Vac	230Vac	277Vac
3klm WHITE	Wattage	22W	22W	22W	25W	25W	25W
	Input Current	0.22A	0.10A	0.08A	0.25A	0.10A	0.09A
6klm WHITE	Wattage	45W	45W	45W	48W	48W	48W
	Input Current	0.45A	0.20A	0.17A	0.48A	0.20A	0.17A
3klm AMBER	Wattage	24W	24W	24W	27W	27W	27W
	Input Current	0.24A	0.10A	0.08A	0.26A	0.11A	0.09A
5klm AMBER	Wattage	46W	46W	46W	49W	49W	49W
	Input Current	0.46A	0.20A	0.16A	0.49A	0.20A	0.17A
3klm GREEN	Wattage	27W	27W	27W	33W	33W	33W
	Input Current	0.27A	0.12A	0.10A	0.33A	0.14A	0.12A



Safety Instruction:

The installation, operation and maintenance must be carried out by an electrician suitably trained in hazardous areas with knowledge of increased safety explosion protection IEC 60079-14.

- The technical data indicated on the LED luminaires are to be observed.
- Changes of the design or modifications to the LED luminaire are not permitted
- Observe the national electrical safety rules and regulations during installation.
- No user serviceable parts inside.

Conformity with Standards:

This equipment conforms to the standards specified in the Declaration of Conformity. It has been designed, manufactured and tested in accordance with BS EN 9001.

ATEX Directive 2014/34/EU: Equipment and protective systems intended for use in potentially explosive atmospheres.

EMC Directive 2014/30/EU: Electromagnetic compatibility.

Equipment and Protective Systems Intended for use in Potentially Explosive Atmospheres Regulations 2016

Electromagnetic Compatibility Regulations 2016

Equipment Application:

This lighting equipment is intended for use in a potentially explosive atmosphere in hazardous locations to the requirements of ATEX Directive 2014/34/EU and Equipment and Protective Systems Intended for use in Potentially Explosive Atmospheres Regulations 2016. See product label for zone.

This product can be used indoors or outdoors to illuminate areas with a potentially explosive atmosphere.

CAUTION: It is important to ensure that the application structure can support the weight of the luminaire. Dialight is not responsible for damage to application structure or to luminaire, if mounted improperly. Inspect the luminaire prior to installation for any physical defects. If any physical defects are noticed, **DO NOT** install luminaire and contact a Dialight representative.

NOTE: This luminaire is supplied with a single plastic dust cap to be replaced by a suitable cable gland. The other entries are supplied with IP-66/67 hazardous location rated blanking plugs.



Repairs / Overhaul / Modification:

The equipment must be operated according to the intended purpose in a perfect and undamaged condition.

NOTE: Select replacement parts are available, please contact factory for details.

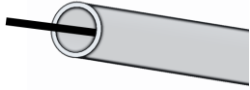
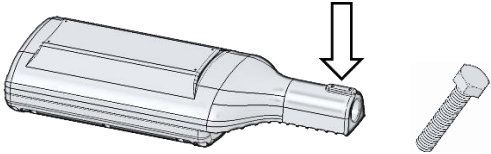
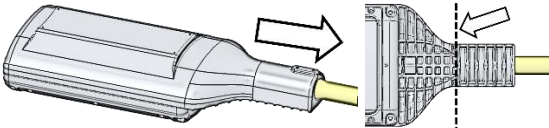
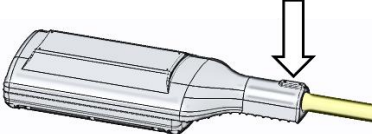
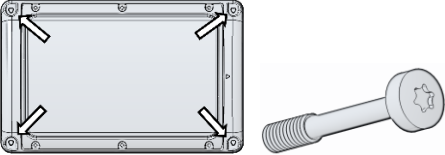
WARNING: Modifications to the device or changes of its design are not permitted.

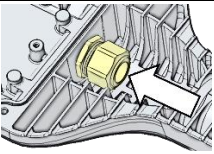
Mounting of Luminaire	
 <p>Pole: Ø 35 (1.3") max Ø 25 (1.0") min (BP Models) or Ø 44 (1.7") max (BZ Models)</p>	Feed source cable through pole
	Back up top hex bolts (M8 x 25) CAUTION: DO NOT REMOVE HARDWARE
	Slide onto pole to indicated location
	Tighten top hex bolts to prevent rotation
	Unthread corner captive screws CAUTION: DO NOT REMOVE HARDWARE

Electrical Connection	
 <p>Cable: Ø 0.44" (11) min – Ø 0.70" (18) max</p>	Install M25 cord grip appropriately sized for intended conductor.
 <p>For push down style: 12-20 AWG (4.0-0.5 mm²) 10-11 mm (0.39"- 0.43") For cage clamp style: 10-20 AWG (6.0-0.5 mm²) 11-13 mm (0.43"- 0.51")</p>	Strip source cable conductor jacket, ground conductor must be equal to or greater than source conductors in cross sectional area.

NON-BATTERY DESIGN

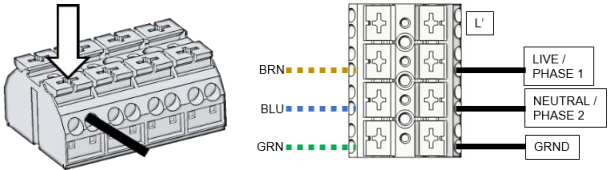
	<p>Push down, insert source conductor and release. Slight tug on source conductor to check engagement WARNING: Only single cable for each terminal entry point.</p>
---	--



Electrical Connections (DALI or Dimming Compatible)

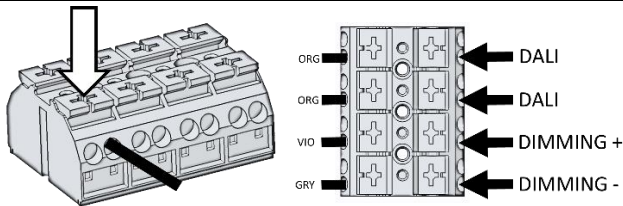

Strip and insert conductor as instructed above
Slight tug on the conductor to check engagement
WARNING: Only single cable for each terminal entry point.

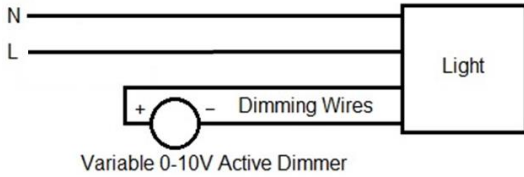

Light output will vary sinking 0.5 mA per light
10 V = 100% light output.
NOTE: Shorting the DIMMING wires together will cause the light to shut off.

Power and Illumination Check



Restore power to check for illumination
CAUTION: Do not look directly into luminaire without protective shaded eyewear

Closing Luminaire

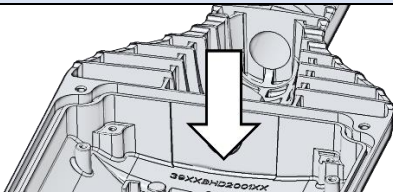

After illumination confirmation, tuck excess cable into luminaire

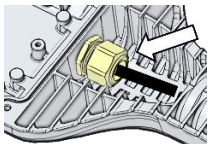

Torque: 7.9 - 8.5 N-m (70 - 75 in-lb)

Tighten cord grip to secure cable

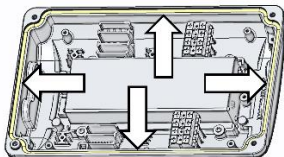

Torque: **1st** = 1 N-m (8.8 in-lb) **FINAL** = 5 N-m (44.2 in-lb)

Ensure O-ring is in place and not damaged
CAUTION: Ensure cables will not be pinched
Tighten corner captive screws (opposite corner sequence)



Final Orientation of Luminaire	
	<p>ATTENTION: Luminaire not intended for uplight application</p>
	<p>Loosen top hex bolts Slide until the pole makes contact with the cord grip</p>
	<p>Tilt unit to its final orientation</p>
<p>Torque = 7 N-m (5 ft-lb)</p>	<p>Tighten top hex bolts</p>

Conditions for Certification:

- The equipment shall not be installed in a location where the external conditions are conducive to the build-up of electrostatic charge on such surfaces. In addition, the equipment shall only be cleaned with a damp cloth.
- All cable entry holes shall be fitted with either an IECEx / ATEX certified cable gland or an IECEx / ATEX certified stopping plug that is suitable for the application. The type of cable, glands and stopping plugs shall have temperature ratings of at least 70°C.
- The terminals shall only be fitted with wires that have cross sectional area falling within the following limitations:
 - WAGO 2004-conductor series terminals: single-core, finely stranded and standard: min. 0.5 mm² to 6 mm²
 - WAGO 862-conductor series terminals: single-core, finely stranded and standard: min. 0.5 mm² to 4 mm²
- The tighten torque of the screws used to fix enclosure shall be equal to 5.0±0.5Nm.
- The equipment shall be installed such that the supply cable is protected from mechanical damage. The cable shall not be subjected to tension or torque. If the cable is to be terminated within an explosive atmosphere then the free end shall be terminated in a suitably certified termination facility.
- Use only replaceable battery pack 9100BHD000100
- Clean the luminaire regularly to prevent dust accumulation.
- IP64 was followed in accordance with IEC/EN 60079-0, IEC/EN 60079-7 and IEC 60079-31
- Temperature code depends on ambient temperature as follows:

T-code	Ambient Temperature
T5 and T95°C	-20°C to 55°C
T4 and T130°C	-40°C to 65°C

Note: BH*****E, BH*****F, BH*****G, BP*****E, BP*****F, BP*****G, BZ*****E, BZ*****F, BZ*****G, luminaire can be used in ambient temperature “-20°C to 55°C” only.

- The manufacturer shall take all reasonable steps to ensure that the user/installer complies with the special conditions for certification associated with the terminal block. In addition, the manufacturer shall provide the user/installer with an appropriate copy of the certificate for each certified terminal that is fitted to the terminal enclosure.



Battery Backup Connection

Battery Pack is **only** charged during AC operation
 Once AC power is lost, **BATTERY MODE** is enabled and will stay on based on the configuration jumper position (Fig.A) below.

BATTERY LIFE: The battery pack should be replaced when it no longer meets the rated duration of operation after testing, mark battery with date of install. Please consult factory for replacement parts.

ATTENTION: Luminaire requires a minimum of **24 continuous hours** of normal operation before the batteries are fully charged. If AC power is interrupted, then the 24 hour clock restarts.

SELF-TESTING: The Luminaire performs tests automatically with delay times and intervals defined in IEC 62034.

Install Duration Test	runs a duration test after 24 continuous hours of normal operation, the light will go into BATTERY MODE based on the configuration jumper
Function Test	will be performed monthly, light will remain in normal operation during test
Annual Duration Test	runs a duration test after 1 year of normal operation, the light will go into BATTERY MODE based on the configuration jumper

GREEN LIGHT = Indicates **NORMAL** status **RED LIGHT** = Indicates **SYSTEM FAULT** status
 Refer to table to identify meaning of flashing lights. Mark battery with date of install.

Battery Indicator Signals		Slow Flash = 0.5 Hz	Fast Flash = 2.5 Hz	
Mode	Indicator LED	System Status	Battery LAMP	Stand-alone / DALI
Battery Standby	Green ON Pulse Every 10s	Normal	Off	Both
Battery Charging in Progress	Green ON Pulse Every 10s	Normal	Off	Both
Function Test in Progress	Green Fast Flash	Self Testing	On	Both
Duration Test in Progress	Green Slow Flash	Self Testing	On	Both
Battery Operation	All Off	Battery Backup	On	Both
Lamp Fault	Red Fast Flash	Fault	Off	Both
Battery Charging Fault	Red Slow Flash	Fault	Off	Both
Battery Duration Fault	Red Slow Flash	Fault	Off	Both
Identification	All Fast Flash	Normal	Off	DALI Mode Only
Rest	All Off	Battery Backup	Off	DALI Mode Only
Prolong	All Off	Battery Backup	On	DALI Mode Only

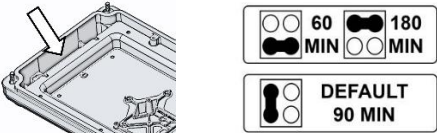
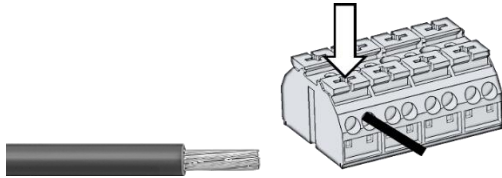

Fig.A

Battery configuration jumper positions



Electrical Connections (Battery Backup)



(for all connections)
Strip and insert source conductor as instructed above
Slight tug on the conductor to check engagement
WARNING: Only single cable for each terminal entry point

PERMANENT MAINTAINED CONNECTIONS

Light is always on, maintains charging, battery mode enabled with loss of AC power

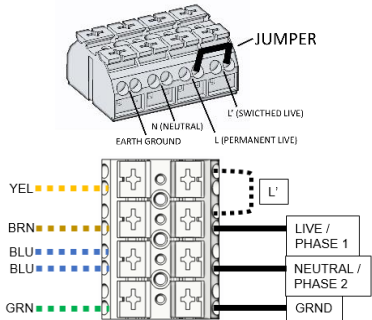

Jumper in place (from factory)

SWITCHED MAINTAINED CONNECTIONS

Switch is added to L` to switch the light on/off, maintains charging, battery mode enabled with loss of AC

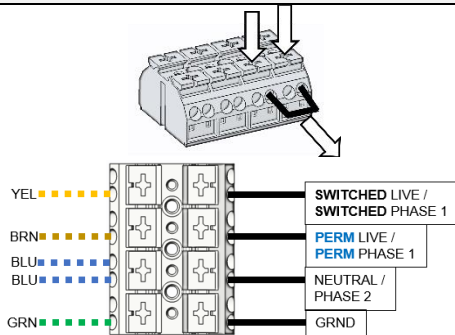

Push down, **remove** jumper and release

NON-MAINTAINED CONNECTIONS

Light is off normally, maintains charging, battery mode enabled with loss of AC

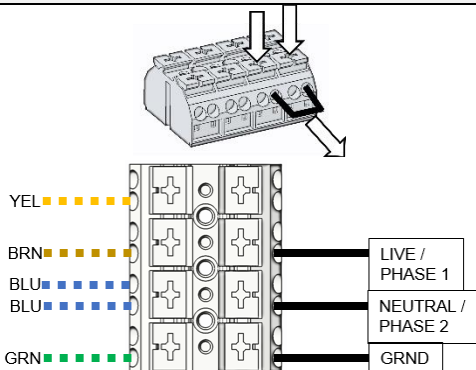

Push down, **remove** jumper and release



Conditions for Use:

The supply to the luminaire must include a fuse which is capable of interrupting a 100 A short circuit current.

When used with steel wired armor or braided cable the basket weave armor or braid is unable to carry the cable load without fracture. The cable must therefore be clamped and cleated to prevent pulling on the cable being transmitted to the cable terminations.

WARNING: Improper installation, operation, or maintenance of this luminaire may result in the invalidation of the warranty, certificate, or declaration of conformity.

For maximum long term reliability and light output, the luminaire must be installed in free air.

Maintenance and Inspection:

Within the scope of maintenance or inspection routine the following should be included:

- Consult the relevant national regulations to determine the type and extent of inspections required
- Adjust inspection intervals accordingly to suit the operating conditions
- Perform maintenance in accordance with IEC 60079-17 and IEC 60079-19
- The lens window and any exterior surfaces to be cleaned periodically using a damp, non-abrasive, lint free cloth.

Repairs / Overhaul / Modification:

The operation of the luminaire must be in accordance to the intended purpose and undamaged condition. Changes and modifications are not permitted to the luminaire.

NOTE: Should the luminaire enclosure be damaged, only a full luminaire replacement will be permitted. In case of doubt, the luminaire should be returned to Dialight for inspection/repair.

Chemical Compatibility Guide:

Chemical compatibility is highly dependent on concentration, temperature, humidity, and other environmental conditions and therefore the customer assumes responsibility for evaluation of gaseous or direct contact chemical compatibility at their site prior to product installation.

Contact your local Dialight representative for more information.

Disposal Recycling:

When the luminaire is disposed of, the respective national/regional regulations on waste disposal should be observed.



Official Statement

All statements, technical information, and recommendations contained herein are based on information and tests that Dialight believes to be reliable. The accuracy or completeness thereof is not guaranteed. In accordance with Dialight Terms and Conditions of Sale and since conditions of use are outside our control, the purchaser should determine the suitability of the product for his or her intended use and assumes all risk and liability whatsoever in connection therewith.

