



Dialight LED Bulkhead - Conveyor

Technical Specification Sheet - EMEA



DECEMBER 2023

SafeSite® LED Bulkhead - Conveyor

Technical Specifications

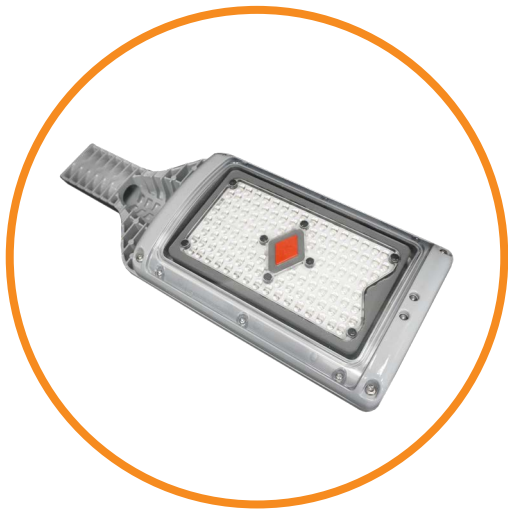

Certifications & Ratings

- 10 year warranty
- ATEX / IECEx Zone 1, 21
 - Ex eb mb IIC T4 Gb
 - EX tb IIIC T130°C Db
- ATEX / IECEx Zone 2, 22
 - Ex ec IIC T4 Gc
 - Ex tc IIIC T130°C Dc
- Ta = -40°C to +65°C for standard models
- Ta = -20°C to +55°C for battery backup models
- IP66/67
- IK10
- DNV
- L70 > 150,000 hours @ 65°C (149°F)

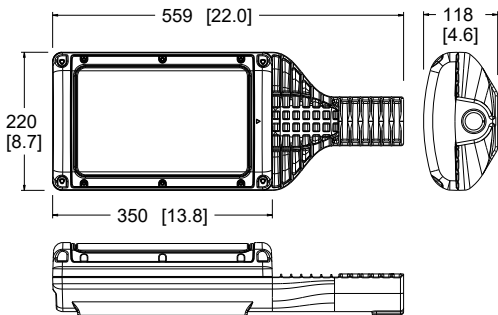

Dimensions in mm (inches)

Mechanical Information:

Fixture weights:	
Standard models:	7.9 kg (17.4 lb)
Battery backup models:	8.8 kg (19.4 lb)
Shipping weights:	
Standard models:	8.4 kg (18.5 lb)
Battery backup models:	9.3 kg (20.5 lb)
Cable entry:	(1) M25
Spigot entry size:	44mm ID Optional 35mm ID

Materials:

Housing:	A360 Die-cast aluminium
Finish:	Superior dual coat finish - Sealed polyester topcoat - Epoxy primer
Lens:	Polycarbonate clear Polycarbonate diffused (optional)
Hardware:	316 Stainless Steel

Electrical Specifications:

Operating voltage:	
Standard models:	100-277 VAC / 120-250 VDC
Battery backup models:	110/120 VAC, 230/240 VAC
Operating temperature:	
Standard models:	-40°C to +65°C (-40°F to +149°F)
Battery backup models:	-20°C to +55°C (-4°F to +131°F)
Surge protection:	6kV/3kA, 1.2/50, 8/20us Combination Wave Line-line and line-ground
THD:	< 18%
Power factor:	> 0.9
Dimming:	DALI 1.0 and 2.0 0-10 VDC continuous dimming to <10%

Battery Backup Models: (integral battery)

Battery duration* (circular optic, clear lens):

6.5k lumen outputs:	180 mins ~ 900 lm
	90 mins ~ 1100 lm
	60 mins ~ 1140 lm
3k lumen outputs:	180 mins ~ 800 lm
	90 mins ~ 1100 lm
	60 mins ~ 1140 lm

Expected battery life: 4 years

Photometric Information:

Lumen output*:	3,000 & 6,500 lm (white light)
CRI:	> 80 (white light)
CCT:	5000K (cool white) 4000K (neutral white) 2700K (warm white) Amber

All values typical unless otherwise stated (tolerance +/- 10%)
* @ 25°C ambient

WARNING - INSTALLATION & SECONDARY RETENTION. Use of any Dialight products without proper installation (including secondary retention / netting) and periodic inspections could cause severe injury or death. Dialight recommends that all installations should use secondary retention / netting (appropriate to the installation environment) where applicable. It is the exclusive responsibility of the contractor, installer and/or end-user to: (a) determine the suitability of the product for its intended application; and, (b) ensure that the product is safely installed (with secondary retention / netting where appropriate) and in compliance with all applicable laws and regulations. To the extent permissible under applicable laws, Dialight disclaims all liability for personal injury and/or other damage resulting from any dislodgment or other dislocation of its products.

Ordering Information

SafeSite® LED Bulkhead - Conveyor

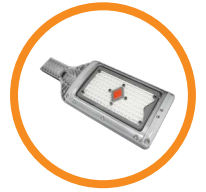

Zone 1, 21

Part Number	Fixture Lumens	Wattage	lm/W	Voltage	CCT	Lens	Beam Distribution
Conveyor Models							
BZA-4UC2-6NNN-VGN	6,200	45	138	100-277VAC / 120-250VDC	5000K (cool white)	Clear Polycarbonate	Ultra-Wide (Type 1)
BZA-4UN2-6NNN-VGN	6,200	45	138	100-277VAC / 120-250VDC	4000K (neutral white)	Clear Polycarbonate	Ultra-Wide (Type 1)
Conveyor Battery Backup Models							
BZA-4UCG-6NNN-VGF	6,200	48	129	230-240VAC	5000K (cool white)	Clear Polycarbonate	Ultra-Wide (Type 1)
BZA-4UNG-6NNN-VGF	6,200	48	129	230-240VAC	4000K (neutral white)	Clear Polycarbonate	Ultra-Wide (Type 1)

Zone 2, 22 or Zone 21

Part Number	Fixture Lumens	Wattage	lm/W	Voltage	CCT	Lens	Beam Distribution
Conveyor Models							
BZB-4UC2-6NNN-VGN	6,400	45	142	100-277VAC / 120-250VDC	5000K (cool white)	Clear Polycarbonate	Ultra-Wide (Type 1)
BZB-4UN2-6NNN-VGN	6,400	45	142	100-277VAC / 120-250VDC	4000K (neutral white)	Clear Polycarbonate	Ultra-Wide (Type 1)
Conveyor Battery Backup Models							
BZB-4UCG-6NNN-VGF	6,400	48	133	230-240VAC	5000K (cool white)	Clear Polycarbonate	Ultra-Wide (Type 1)
BZB-4UNG-6NNN-VGF	6,400	48	133	230-240VAC	4000K (neutral white)	Clear Polycarbonate	Ultra-Wide (Type 1)

All values typical unless otherwise stated (tolerance +/- 10%).
 2700k models available on request
 35mm spigot entry option available

Accessories

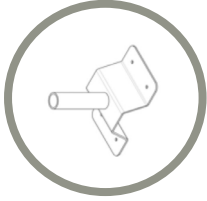

HZX-SPIGOT-34
 • Aluminium wall mount spigot plate - 34mm

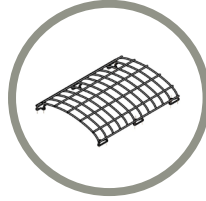

BH-WG-KIT
 • Stainless steel wire guard kit

Beam Distribution

Ultra-Wide Walkway (Type 1) - Clear

Zone 1

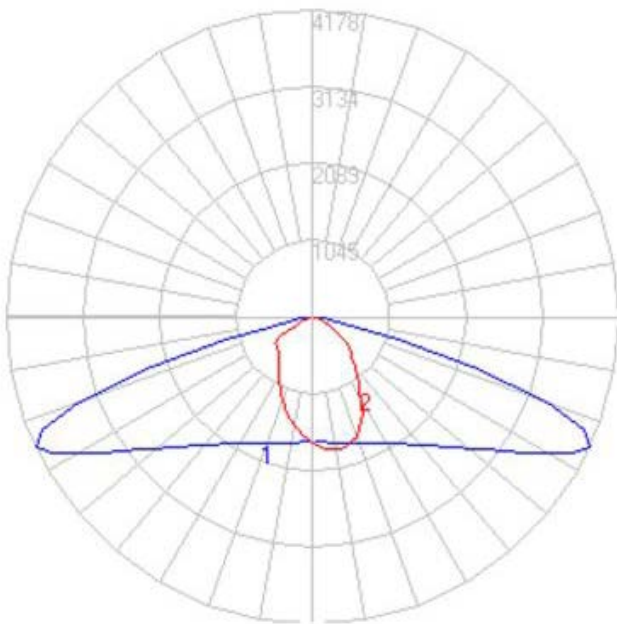

Zone 2

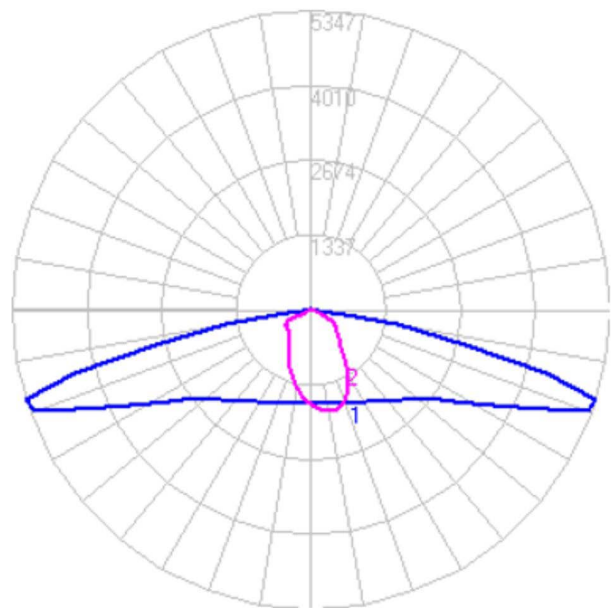

Lumen Maintenance Factor

Bulkhead 6,500lm								
Ambient Temperature	Hours							
	0	15000	30000	45000	60000	75000	90000	100000
25°C	100%	98%	96%	95%	93%	92%	90%	90%
30°C	100%	98%	96%	95%	93%	92%	90%	90%
35°C	100%	98%	96%	95%	93%	92%	90%	90%
40°C	100%	98%	96%	95%	93%	92%	90%	90%
45°C	100%	98%	96%	95%	93%	92%	90%	90%
50°C	100%	97%	96%	95%	93%	92%	90%	89%
55°C	100%	97%	96%	95%	93%	92%	90%	89%
60°C	99%	97%	95%	94%	93%	91%	90%	89%
65°C	99%	97%	95%	94%	92%	91%	89%	89%

Based on 9,000 hour LM80 data

DISCLAIMER. All product information provided is, to the best of Dialight's knowledge, accurate as of the date of publication. When ordering, refer to www.dialight.com for current versions of: (a) relevant product documentation (including the relevant product data sheets); (b) Dialight terms and conditions of sale; and, (c) the relevant product warranty. To the extent that any contract is deemed formed between Dialight and the purchaser of Dialight products and/or an end-user, versions of documents available at www.dialight.com as at the date of sale shall be the versions incorporated therein. In the event of any discrepancy between this document or information provided at www.dialight.com, the latter shall prevail.

Thermal Roll-Off

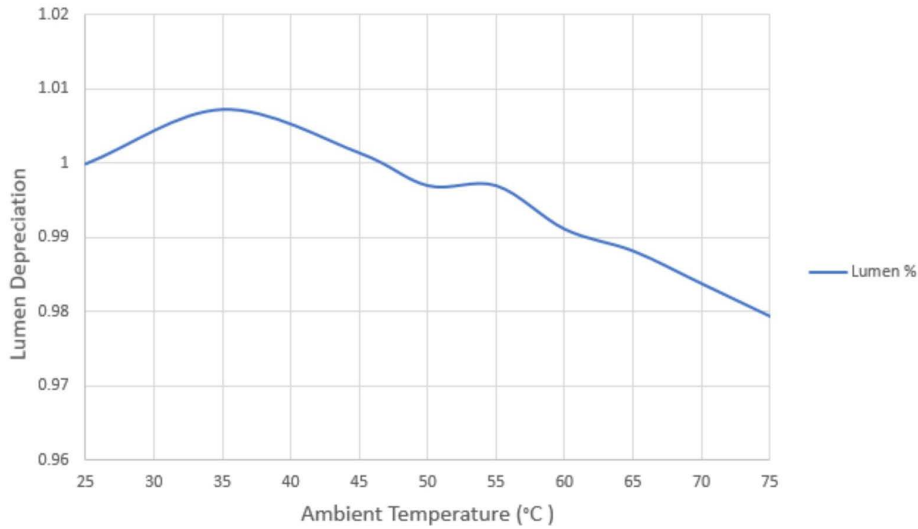

Inrush Current / Circuit Breakers

Output	In rush (A) current @ input voltage							
	100 VAC	Duration (MS)	120 VAC	Duration (MS)	230 VAC	Duration (MS)	277 VAC	Duration (MS)
6,500	6	0.6	8	0.6	15	0.6	18	0.6

Output	GND Leakage (mA) input voltage			
	100 VAC	120 VAC	230 VAC	277 VAC
6,500	0.5	0.5	0.8	1.0

DISCLAIMER. All product information provided is, to the best of Dialight's knowledge, accurate as of the date of publication. When ordering, refer to www.dialight.com for current versions of: (a) relevant product documentation (including the relevant product data sheets); (b) Dialight terms and conditions of sale; and, (c) the relevant product warranty. To the extent that any contract is deemed formed between Dialight and the purchaser of Dialight products and/or an end-user, versions of documents available at www.dialight.com as at the date of sale shall be the versions incorporated therein. In the event of any discrepancy between this document or information provided at www.dialight.com, the latter shall prevail.

Dimming Curves

DALI Dimming

6,500lm

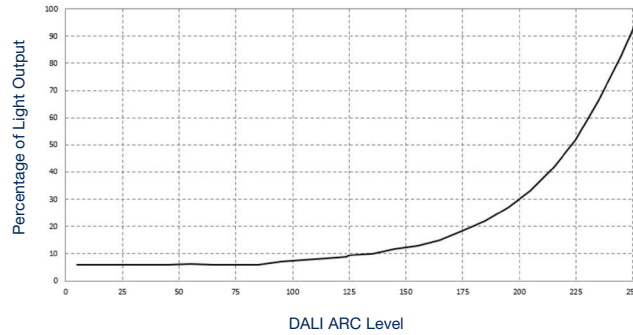

0-10V Dimming

6,500lm

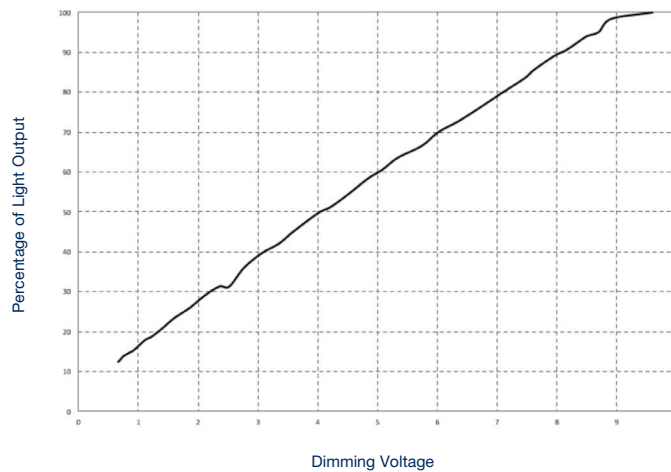

DISCLAIMER. All product information provided is, to the best of Dialight's knowledge, accurate as of the date of publication. When ordering, refer to www.dialight.com for current versions of: (a) relevant product documentation (including the relevant product data sheets); (b) Dialight terms and conditions of sale; and, (c) the relevant product warranty. To the extent that any contract is deemed formed between Dialight and the purchaser of Dialight products and/or an end-user, versions of documents available at www.dialight.com as at the date of sale shall be the versions incorporated therein. In the event of any discrepancy between this document or information provided at www.dialight.com, the latter shall prevail.

Dialight Europe Ltd

Leaf C, Level 36, Tower 42
25 Old Broad Street
London, EC2N 1HQ, United Kingdom
Tel: +44 (0) 203 058 3540
Customer Service: +44 (0) 163 866 6541
sales-emea@dialight.com

Southeast Asia

56 Kallang Pudding Road
#09 – 08 HH@Kallang
Singapore 349328
Tel: +65 6578 7271
Fax: +65 6578 7150
enquiry@dialight.com.sg

WARNING / DISCLAIMERS:

Installation & secondary retention. The use of this product without proper installation (including secondary retention / netting) and periodic inspections, could cause severe injury or death. Dialight recommends that all installations should use secondary retention / netting (appropriate to the installation environment) as applicable. Dialight products are intended for ultimate purchase, installation and operation by knowledgeable persons trained in the functional assessment, installation, use and maintenance of such products and all customers (including but not limited to end customers) are responsible for assessing the suitability of Dialight products for any given installation requirement. It is the exclusive responsibility of the contractor, installer and/or end-user to: (a) determine the suitability of the product for its intended application; and, (b) ensure that the product is safely installed (with secondary retention / netting as appropriate) and in compliance with all applicable laws and regulations.

Product specifications & warranties. All product information provided is, to the best of Dialight's knowledge, accurate as of the date of publication. All values and performance data herein are design or typical values when measured under laboratory conditions. The information herein is subject to change without notice. The products / software detailed herein are subject to applicable warranties and terms and conditions of use/purchase. Unless agreed otherwise in writing by an authorized representative of Dialight, Dialight does not represent that its products are fit for any particular purpose and accepts no liability for the installation and/or unauthorised use of its products. When ordering, refer to www.dialight.com for current versions of: (a) relevant product documentation (including relevant product data sheets); (b) Dialight terms and conditions of sale; and, (c) the relevant product warranties. To the extent that any contract is deemed formed between Dialight and the purchaser of Dialight products and/or an end-user, versions of documents available at www.dialight.com as at the date of sale shall be the versions incorporated therein. In the event of any discrepancy between this document and information provided at www.dialight.com, the latter shall prevail.

Exclusion of liability. To the extent permissible under the relevant law, Dialight disclaims all liability for personal injury and/or other damage resulting from any dislodgment or other dislocation of its products. Whilst Dialight has used its reasonable endeavours to ensure the completeness and accuracy of information herein, Dialight does not assume any liability for damages resulting from use of this information or for any third-party representations made in relation to Dialight products.